

Users guide CompactPCI Power Backplanes 23098-393, 23098-394, 23098-395, 23098-396

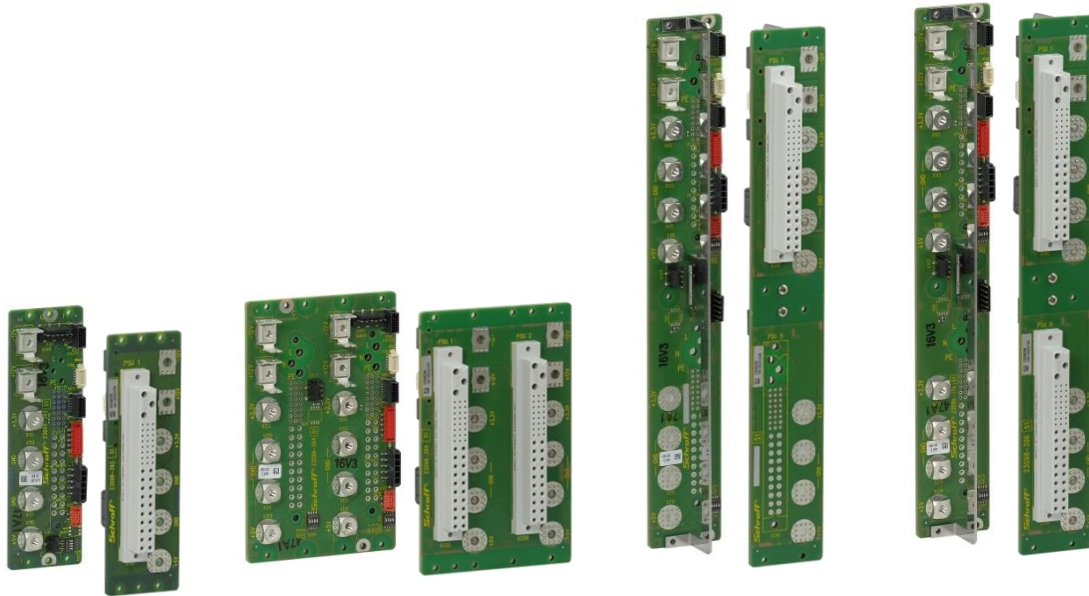

PICMG 2.11 defines the mechanical and electrical interface for pluggable power supplies in 3U or 6U height for powering a CompactPCI application. The P47 PSU connector and mating backplane connector are defined as well as status, redundancy and utility signals. The Schroff CompactPCI Power Backplanes are in accordance to the PICMG 2.11 R1.0 specification.

The Schroff CompactPCI Power Backplane family includes all necessary types of backplanes to feed a CompactPCI application with the power from 3U or 6U pluggable CompactPCI power supply in single, parallel or redundant configuration with up to 4 PSU's.

Features

In accordance to

PICMG 2.11 R1.0 CompactPCI Power Interface Specification

PICMG 2.9 R1.0 System Management Bus Specification

Single, Parallel or redundant operation possible

High DC current outputs with virtually zero voltage drop

Geographical address adjustable

Mains supply via crimp contacts insertable into P47 plug, no mains voltage in the CompactPCI Power Backplane

Information about producer

Schroff GmbH
D-75334 Straubenhardt

The details in this manual have been carefully compiled and checked.

Pentair Technical Solutions GmbH cannot accept any liability for errors or misprints. The company reserves the right to amendments of technical specifications due to further development and improvement of products.

Users guide CompactPCI Power Backplanes 63972-364, Rev. 1.4, Jan 2022

Assembly Instructions & General Information

Mounting

Attach the power backplane using every non-plated mounting hole at the top and the bottom to fix the backplane to the system/subrack with M2.5 screws.

Chassis GND

If only the non-plated mounting holes are used the backplane GND will be isolated from the chassis GND.

On the top and bottom mounting hole rows there are 2 mounting holes near each other, one plated, marked with a "C" and one non-plated, marked with an "I".

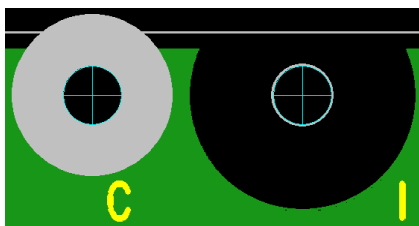

Mounting holes for „I“ isolated or „C“ connected mounting of backplane GND to Chassis GND

If connected mounting of the backplane is required, please assemble screws in each plated mounting hole of the backplane. Spring washers are recommended instead of flat washers.

If both grounds are isolated, creepage and clearance between screw and digital GND are in accordance with EN 62368-1.

Power output

The backplane provides power terminals with M4 thread power bugs and bush elements to connect the main voltages. M4 cable lugs should be used to connect the power cables to the power bugs and power elements. A maximum of 2 cable lugs are recommended per power bug. Please assemble the cable lugs with the flat side to the power bug to ensure the correct isolation distance between the not insulated part of the power cable and not insulated parts of the backplane.

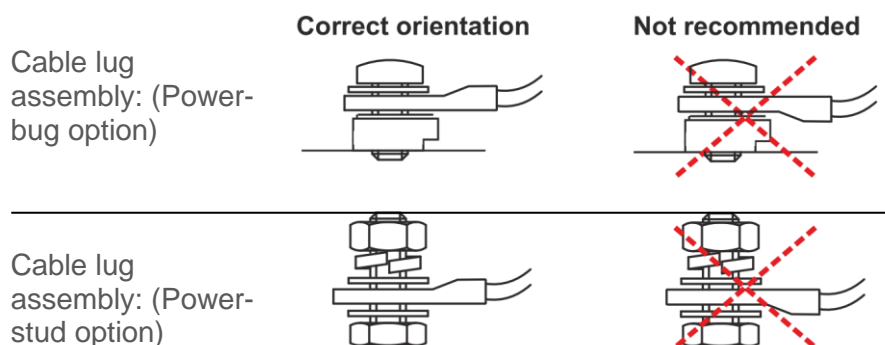

For harsh environments with very high shock and vibration values a power stud with nuts is recommended. Schroff power backplanes are already prepared to accept a power stud instead of the power bugs assembled as standard option. Please ask your Schroff sales contact for a configured version with M4 power studs assembled or send an inquiry to backplanes@nvent.com. The power stud accepts a maximum of 2 cable lugs.

Start-up of the board

Open the cable tie of the power mains cable and push the crimp contacts into the dedicated connector chambers of X100. Respect the cable colors: brown: L (line); blue: N (neutral); green/yellow: PE (protective earth). The other end of the power mains cables can be fitted with Faston Crimp contacts (please order the power mains cable set, including the fastons separately).

Status and control signals

INH#: Signal to turn the PSU outputs “on / off”. “Open” or “high” = on; “Low” = off.

The INH# signal from the P47 connector or both P47 connectors is connected to the corresponding pins INH#_1 and INH#_2 of the PSU enable connector X107. If the output voltages should be deactivated for PSU 1 or 2 the corresponding INH# pin of the connector X107 should be grounded by installing a jumper on pin 1 and 2 respective pin 3 and 4.

As an alternative assembly option the INH# signal can be provided on the utility connectors 1, 2 and 3 or the output on / off selection can be selected by an optional dip switch. Please ask your Pentair sales representative if you need one of those setups.

FAL#: Signal driven by intelligent PSU's, at least one output has failed (is out of range).

The signal is available on the utility connectors 1 to 3. At power backplanes with 2 P47 connectors the FAL# signals of both PSU's are connected to the FAL# pin of the utility connectors. If the output of at least one PSU has failed the output is active.

DEG#: Signal driven by intelligent PSU's, PSU indicates that the supply is beginning to derate its power output

The signal is available on the utility connectors 1 to 3. At power backplanes with 2 P47 connectors the DEG# signals of both PSU's are connected to the DEG# pin of the utility connectors. If the output of at least one PSU begins to derate the output is active.

PRST#: Signal may be used in a CompactPCI system to reset the System Slot board by a switch closure or an open-collector driver

This signal is connected in between the Utility connectors 1 to 3 and the Remote connector X101.

IPMB Is the Intelligent Platform Management Bus, defined in PICMG 2.9 R1.0

The IPMB is connected in between the P47 connectors and the IPMI connector X102

Sense Pins referred to voltages +5V; +3,3V; +12V and GND of these connector used for sense purposes. They should be connected to the backplane. Some Power Supplies need at least a connection between Sense_RTN and GND, otherwise the outputs overrun.

Backplane rear view

X100 and X200 are assembled from front

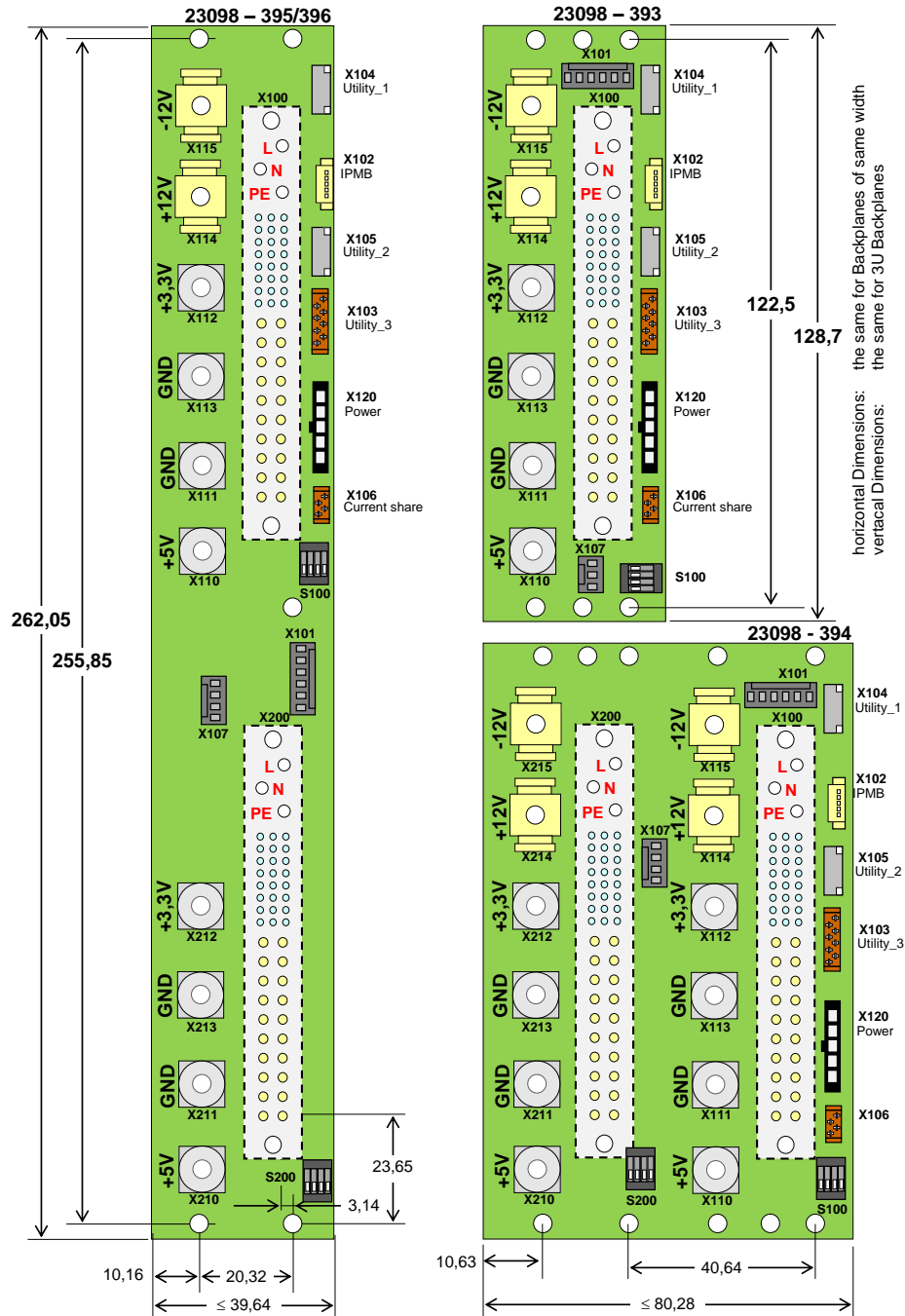

Pin assignment P47 Power connector (X100 and X200)

Pin#	Signal Name	Description
1	V1	V1 Output (+5V)
2	V1	V1 Output (+5V)
3	V1	V1 Output (+5V)
4	V1	V1 Output (+5V)
5	RTN	V1 and V2 Return (GND)
5	RTN	V1 and V2 Return (GND)
7	RTN	V1 and V2 Return (GND)
8	RTN	V1 and V2 Return (GND)
9	RTN	V1 and V2 Return (GND)
10	RTN	V1 and V2 Return (GND)
11	RTN	V1 and V2 Return (GND)
12	RTN	V1 and V2 Return (GND)
13	V2	V2 Output (+3,3V)
14	V2	V2 Output (+3,3V)
15	V2	V2 Output (+3,3V)
16	V2	V2 Output (+3,3V)
17	V2	V2 Output (+3,3V)
18	V2	V2 Output (+3,3V)
19	RTN	V3 Return (GND)
20	V3	V3 Output (+12V)
21	V4	V4 Output (-12V)
22	RTN	Signal Return (GND)
23	RESERVED	Reserved
24	RTN	V4 Return (GND)
25	GA0	Geographic Address Bit 0
26	RESERVED	Reserved
27	EN#	Enable (set to GND)
28	GA1	Geographic Address Bit 1
29	V1ADJ	V1 Adjust
30	V1 SENSE	V1 Remote Sense (+5V_SENSE)
31	GA2	Geographic Address Bit 2
32	V2ADJ	V2 Adjust
33	V2 SENSE	V2 Remote Sense (+3,3V_SENSE)
34	S RTN	Sense Return (set to GND by default, via switch)
35	V1 SHARE	V1 Current Share (+5V_SHARE)
36	V3 SENSE	V3 Remote Sense (+12V_SENSE)
37	IPMB_SCL	System Management Bus
38	DEG#	Degrade Signal
39	INH#	Inhibit
40	IPMB_SDA	System Management Bus
41	V2 SHARE	V2 Current Share (+3,3V_SHARE)
42	FAL#	Fail Signal
43	IPMB_PWR	System Management Bus
44	V3 SHARE	V3 Current Share (+12V_SHARE)
45	CGND	Chassis Ground (safety ground)
46	ACN/+DC IN	AC Input – Neutral; +DC Input
47	ACL/-DC IN	AC Input – Line; -DC Input

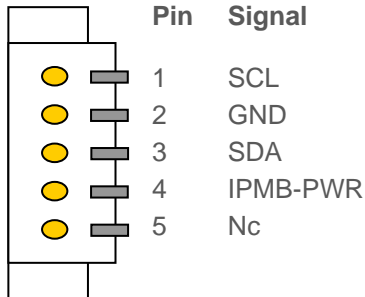
IPMB Connector (X102)
 top view on connector

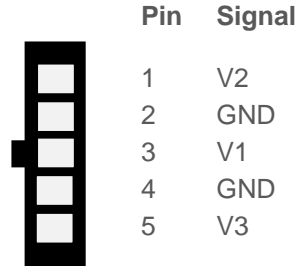
 free connector: Molex # 51021-0500
 crimp contact: Molex # 50079-8100

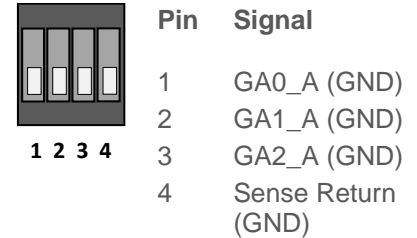
Power Connector (X120)
 top view on connector

 board connector: Molex #43650-0524
 free connector: Molex # 43645-0508
 (IDC, AWG 16)

PSU address (S100, S200)
 top view on switch

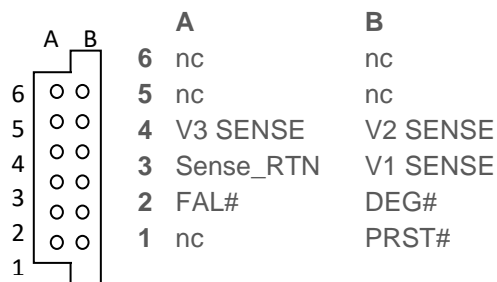
 Default = closed
 S100: GA address PSU 1
 S200: GA address PSU 2

Utility 1, 2 Connector (X104, X105)

Top view on connector



free connector: ERNI part#:044663

Utility 3 Connector (X103)

top view on connector

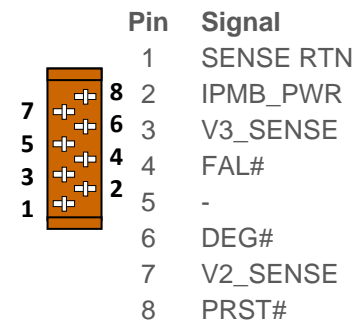

Current share (X106)

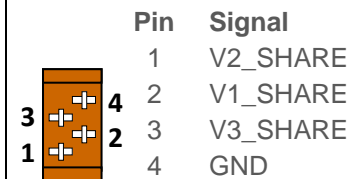
top view on connector

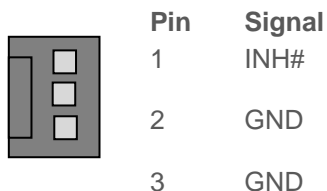
 board connector: TE # 7-338069-4
 free connector: TE # 7-338728-4

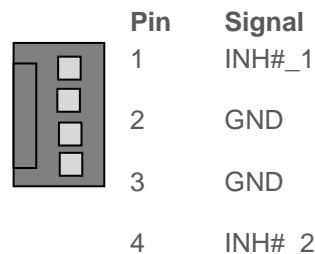
PSU enable (X107)
 for 23098-393
 top view on connector

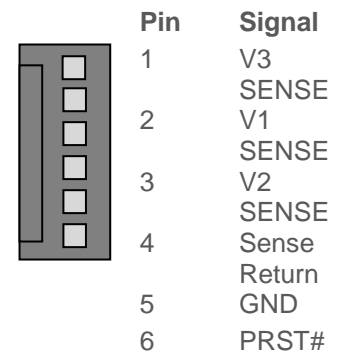
 board connector: TE # 3-647166-3
 free connector: TE # 3-640443-3

PSU enable (X107)
 for 23098-394, -395, -396
 top view on connector

 board connector: TE # 3-647166-4
 free connector: TE # 3-640443-4

Remote Connector (X101)
 top view on connector

 board connector: TE # 3-647166-6
 free connector: TE # 3-640443-6

Part numbers Power Backplanes

Part number	Description
23098-393	3 U, 8 HP, 1x P 47 connector
23098-394	3 U, 16 HP, 2x P 47 connectors
23098-395	6 U, 8 HP, 1x P 47 connector
23098-396	6 U, 8 HP, 2x P 47 connector

Part numbers Accessory Cables

Part number	Power Backplane Connector	Description
23204-110	X100, X200	Mains input, 3 wire, 500 mm
23204-115	X104, X105	Utility cable, 350 mm, 12 pin header on both ends
23204-116	X104, X105	Utility cable, 600 mm, 12 pin header on both ends
23204-113	X102	IPMB cable, 750 mm, 5 pin header on both ends
23204-867	X106	Current-sharing flat ribbon cable, 150 mm, 2 x 4-pin Micro-Match
23204-811	X103	Utility cable, header / header
23204-812	X103	Utility cable, header / open end

Technical data

Further requirements on request at backplanes@nvent.com

Mechanical and climatic parameters	
Operating temperature	-55° C to +85° C
Storage temperature	-55 °C to +125 °C
Humidity with conformal coating	max. 95 %, not condensing
Flammability: PCB, connectors and components Ceramic caps	UL 94 V-0 Fire-proof
Mechanical durability Mating cycles Insertion/extraction force: Durability: All signal contacts powered at All power contacts powered at	250 cycles <110N / per Power Connector 3 Amp / pin 30 Amp / pin
Dimensions (mm) Width (please see drawing) Height 3U / 6U Thickness	3U/1 Slot = 128,7mm x 78,99mm 3U/2 Slot = 128,7mm x 38,4mm 6U/2 Slot = 262,05mm x 38,4mm 3,2 mm +/- 10% mm

Electrical Parameters:	
Supported bus types System Management Bus (I ² C / SMB)	100 kbps / 400kbps / 1Mbps
Hot swap	supported
Power input	Power bugs , Power elements, power studs (on request)
Max. current carrying capacity V1(+5V)/GND V2(+3,3V)/GND V3 (+12V)/ GND V4 (-12V)/ GND	40 Amp per Slot on a 3U and 6U Power BPL 40 Amp per Slot on a 3U and 6U Power BPL 5 Amp per 3U Power BPL 1 Amp per 3U Power BPL
Current carrying capacity Power bug (X114, X115 and X214, X215): Power bush element (X110-X113 and X210-X213):	30 Amp 90 Amp