

---

# PXI Express Controller, 3U 4 TE, I5-1145G7E 32-1024

---

## User Manual

Release 1.0  
22.02.2024

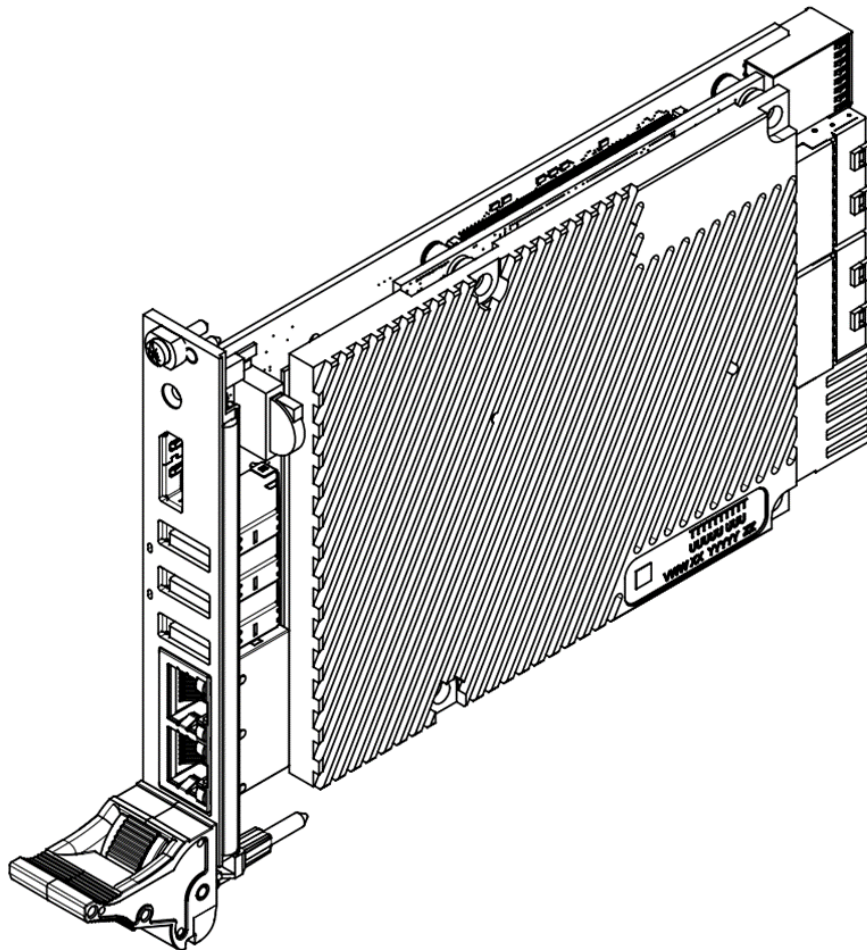

Doc-No: 63972-441

SCHROFF GmbH  
Langenalber Str. 96-100  
75334 Straubenhardt/Germany  
[SCHROFF.nVent.com](http://SCHROFF.nVent.com)

R1.0	February 2024	Preliminary Release

Table 1: Revision History

This document is furnished under license and may be used or copied only in accordance with the terms of such license. The content of this manual is furnished for informational use only, is subject to change without notice, and should not be construed as a commitment by nVent. nVent assumes no responsibility or liability for any errors or inaccuracies that may appear in this document.

Except as permitted by such license, no part of this publication may be reproduced, stored in a retrieval system, or transmitted, in any form or by any means, electronic, manual, recording, or otherwise, without the prior written permission of nVent.

All nVent marks and logos are owned or licensed by nVent Services GmbH or its affiliates. All other trademarks are the property of their respective owners. nVent reserves the right to change specifications without notice.

---



---



---

*Copyright © 2024 nVent  
All Rights Reserved.*

## Table of Contents

<b>1</b>	<b>References and Architecture Specifications .....</b>	<b>5</b>
1.1	Related Documents.....	5
1.2	Safety Certification .....	5
1.3	CE / UKCA Compliance .....	5
<b>2</b>	<b>Technical Information.....</b>	<b>6</b>
2.1	Description.....	6
2.2	Functional Block Diagram.....	6
2.3	Technical Data .....	7
2.4	General View.....	8
2.5	Interchangeable Components .....	9
2.6	Technical Drawings.....	10
<b>3</b>	<b>General Installation.....</b>	<b>11</b>
3.1	Unpacking.....	11
3.2	Getting Started / Initial Operation .....	11
3.3	Safe Shutdown Sequence .....	12
3.4	Power Loss Behaviour .....	12
3.5	Cooling recommendations for higher CPU load applications .....	12
3.6	Supported Operating Systems .....	13
3.7	Software and Driver Installation.....	13
<b>4</b>	<b>Interface description.....</b>	<b>14</b>
4.1	Front Panel LED Indicators .....	14
4.2	DisplayPort.....	14
4.3	USB .....	14
4.4	Ethernet .....	15
4.5	I <sup>2</sup> C / SMBUS Interface.....	15
<b>5</b>	<b>Safety.....</b>	<b>16</b>
5.1	Safety Instructions - Disclaimer .....	16
5.2	Safety Symbols .....	16

<b>6 Service</b> .....	<b>17</b>
6.1 Technical support and Return for Service Assistance.....	17
6.2 Warranty .....	17
6.3 Disposal .....	17
<b>7 Figures</b> .....	<b>18</b>
<b>8 Tables</b> .....	<b>18</b>

# 1 References and Architecture Specifications

## 1.1 Related Documents

This product meets the requirements of the following specifications:

- IEEE 1101.1-199, including IEC 603-2 Connectors
- IEEE 1101.10, including IEEE 1101.1 Equipment Practice,
- ATX Specification Version 2.4
- PICMG EXP.0 Revision 2.0 CompactPCI Express Specification
- PICMG 2.0 R3.0 CompactPCI Specification
- PXI-1 Hardware Specification Rev 2.3
- PXI-2 Software Specification Rev 2.6
- PXI-5 PXI Express Hardware Specification Rev 1.1

## 1.2 Safety Certification

The product is designed to meet the requirements of the following electrical equipment safety standards for measurement, control and laboratory use.

- EN 61010-1 / IEC 61010-1

## 1.3 CE / UKCA Compliance

Essential requirements of applicable European Directives are met by this product. Since 2020 the UKCA declaration requirements are fulfilled as well.

- LVD 2014/35/EU Low-Voltage Directive
- EMC 2014/30/EU Electromagnetic Compatibility Directive
- RoHS 2011/65/EU RoHS Directive 2

Products fulfilling those requirements are marked with a CE/UKCA label.

For Declarations of Conformity of this product please visit <https://SCHROFF.nvent.com/>

## 2 Technical Information

### 2.1 Description

The nVent SCHROFF PXI Express / CPClexp Embedded Controller 21265-124 delivers exceptional performance and versatility in a remarkably compact 3U, one-slot form factor. Powered by an 11th Generation Intel® Core™ i5-1145G7E processor, it boasts four cores clocked at 1.5 GHz with 8 MB cache and a low 15W TDP, ensuring efficient operation without sacrificing processing power. The integrated Xe (Gen 12) graphics engine with up to 96 Execution Units further enhances its capabilities for demanding visual applications. Additionally, the inclusion of the RTS Real-Time Hypervisor opens doors for complex real-time control tasks.

This controller shines in terms of connectivity, supporting either a 4-port (x4x1x4x1) or 2-port (x4x4) system slot configuration, enabling flexible system expansion and data transfer speeds of up to 14 GB/s. The versatile front panel interface provides a DisplayPort++ 1.4 connection for high-resolution displays, two 2.5 GbE Ethernet ports with Time-Sensitive Networking (TSN) support, and three USB 3.1 Gen2 Type A ports for connecting various peripherals.

Storage and memory are equally impressive, with a spacious 1 TB M.2 PCIe NVMe SSD ensuring fast data access and a generous 32 GB DDR4 memory (with room for expansion to 64 GB) guaranteeing smooth program execution and multitasking.

For other configurations regarding CPU, DDR4 memory, hard disk capacity or visual adjustments (heat sink, front panel, surfaces), please contact your responsible sales partner.

### 2.2 Functional Block Diagram

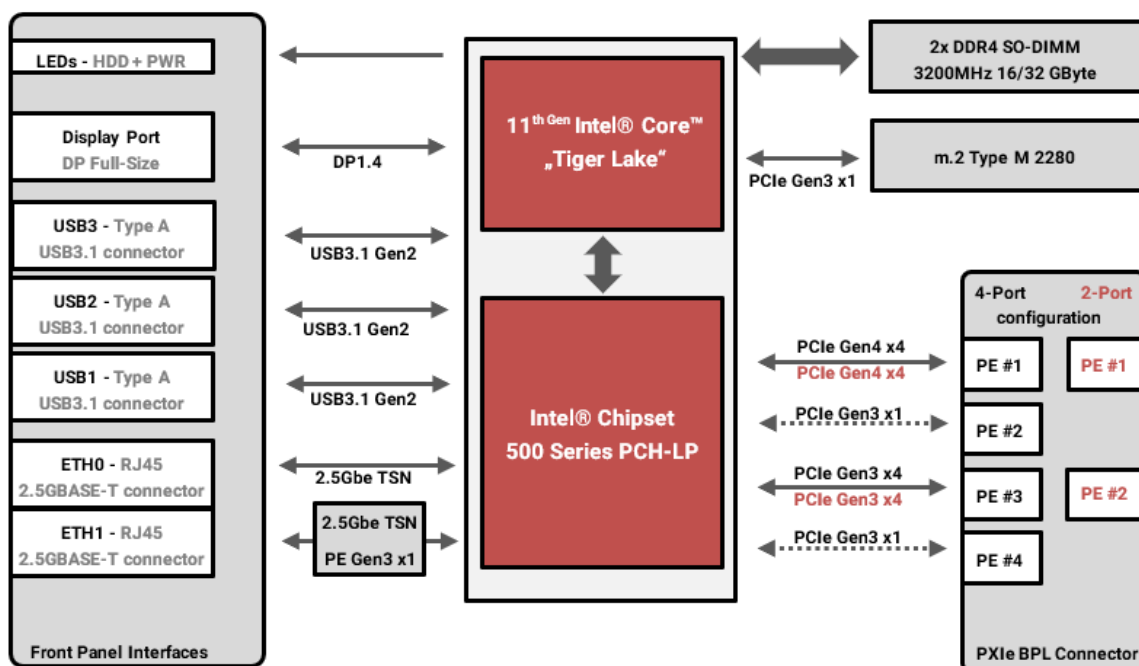

## 2.3 Technical Data

The following table provides general technical product information of the nVent SCHROFF PXI Express Embedded Controller 21265-124.

<b>Physical parameters</b>		
Height		128.7 mm (aligns with 3U card cages)
Width		20.3 mm (4TE)
Depth		212.3 mm (165.04 mm without handle)
Weight		0,44 kg
<b>Compute parameters</b>		
CPU		Intel® Core™ i5-1145G7E (4 x 1.5/4.1 GHz, 8 MB cache, 15W)
Main Memory		Dual Channel (1 of 2 modules equipped) 1x DDR4 32 GB 3200MHz 1V2 CL22
Hard Drive		1x M.2 2280 1TB PCIe NVMe (x1 Gen3)
<b>Interfaces</b>		
Ethernet		2x 2.5G BASE-T RJ45 Ports
Graphics		1x DP++ 1.4 Port with Integrated Intel Xe (Gen 12) graphics engine with up to 96 EU
USB		3x USB3.1 Gen2 Type A
PXI Express System Slot Connectivity (1PE-3PE/1PE-2PE)		4 Port           x4x1x4x1 2 Port           x4x4 (capable of up to PCIe Gen4, Gen3)
<b>Management and Power</b>		
BIOS		AMI Aptio® V UEFI 2.x on 32 MB SPI flash
Board Management Controller		Multi-stage watchdog, Non-Volatile storage, Hardw. monitoring, statistics, I <sup>2</sup> C, Fan Ctrl.
Security		Trusted Platform Module (TPM 2.0)
Power Demands		12.0 V           typ. 0.8 A           max. 2.3 A 5.0 V            typ. 1.5 A           max. 4.5 A 5.0 Vaux        typ. 0.2 A           max. 0.5 A Supports ACPI 5.0a and ATX2.2
<b>Ambient</b>		
Operation		+0 °C to +45 °C
Storage		-40 °C to +85 °C
Admissible humidity		20 % to 80 %, non-condensing, 2000m
Pollution degree		2
<b>Shock and Vibration</b>		
Shock		15 g peak, 11 ms halfsine EN 60068-2-27
Vibration	operation	5 to 100 Hz, 0,15 g rms EN 60068-2-64
	non-operation	5 to 500 Hz, 1,87 g rms EN 60068-2-64

Table 2: Technical Data

## 2.4 General View

The compact 4 TE, 3U PXI Express controller 21265-124 features a front panel equipped with a convenient latch-off mechanism for easy access to the interior. A mounted heat sink ensures efficient thermal management, keeping the system cool and reliable.

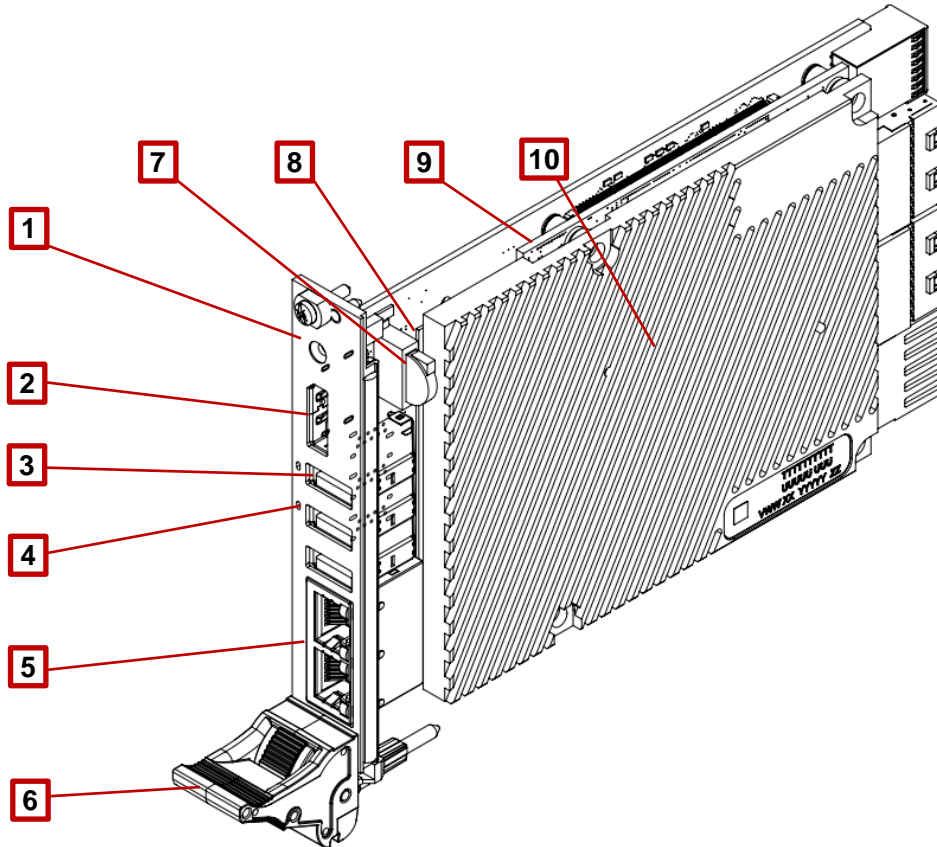



Figure 1: Isometric Front View

1	Front Panel 3U 4TE	6	Front handle with lock and ejector
2	Display Port DP++ 1.4 connector	7	CR1225 Battery 3.0V
3	USB3.1 Type A connectors	8	M.2 NVMe 2280 drive
4	Status LEDs (HDD, PWR)	9	CPU Carrier Board
5	RJ45 Ethernet connectors Front handle with lock and ejector	10	Heat Sink



## 2.5 Interchangeable Components

	<p>Generally the controller is easily maintainable and ready for hardware updates by changing modular core components. <b>Please note that there is no longer a warranty claim after technical modifications. For replacement accessory or mixed hardware inquires contact us!</b></p>
---	--

BIOS Battery:            63918013      CR1225 Lithium 3V Battery Cell

	<p>Please check polarity indication on the battery cell and Battery holder before assembling or changing battery cell. BIOS does not save configuration changes when battery is inserted wrong.</p>
---	---

CPU Variants<sup>1</sup>:            I3-1115G4E CTR  
                                   **I5-1145G7E CTR (installed)**  
                                   I7-1185G7E CTR

<sup>1</sup>also available as ITR versions (Industrial Temperature Range)

Main Memory<sup>2</sup>:            8 GB DDR4 SODIMM 3200MHz CL22  
                                   16 GB DDR4 SODIMM 3200MHz CL22  
                                   **32 GB DDR4 SODIMM 3200MHz CL22 (installed)**

<sup>2</sup>one of two DDR4 sockets occupied. Possible is splitting into two bars or adding a second.

Hard Drive:            M.2 22080 250GB PCIE 3.0 NVME  
                                   M.2 22080 500GB PCIE 3.0 NVME  
                                   **M.2 22080 1TB PCIE 3.0 NVME (installed)**

other modifications:    BIOS Logo, custom Heat sinks or front panels, etc. **upon request**

2.6 Technical Drawings

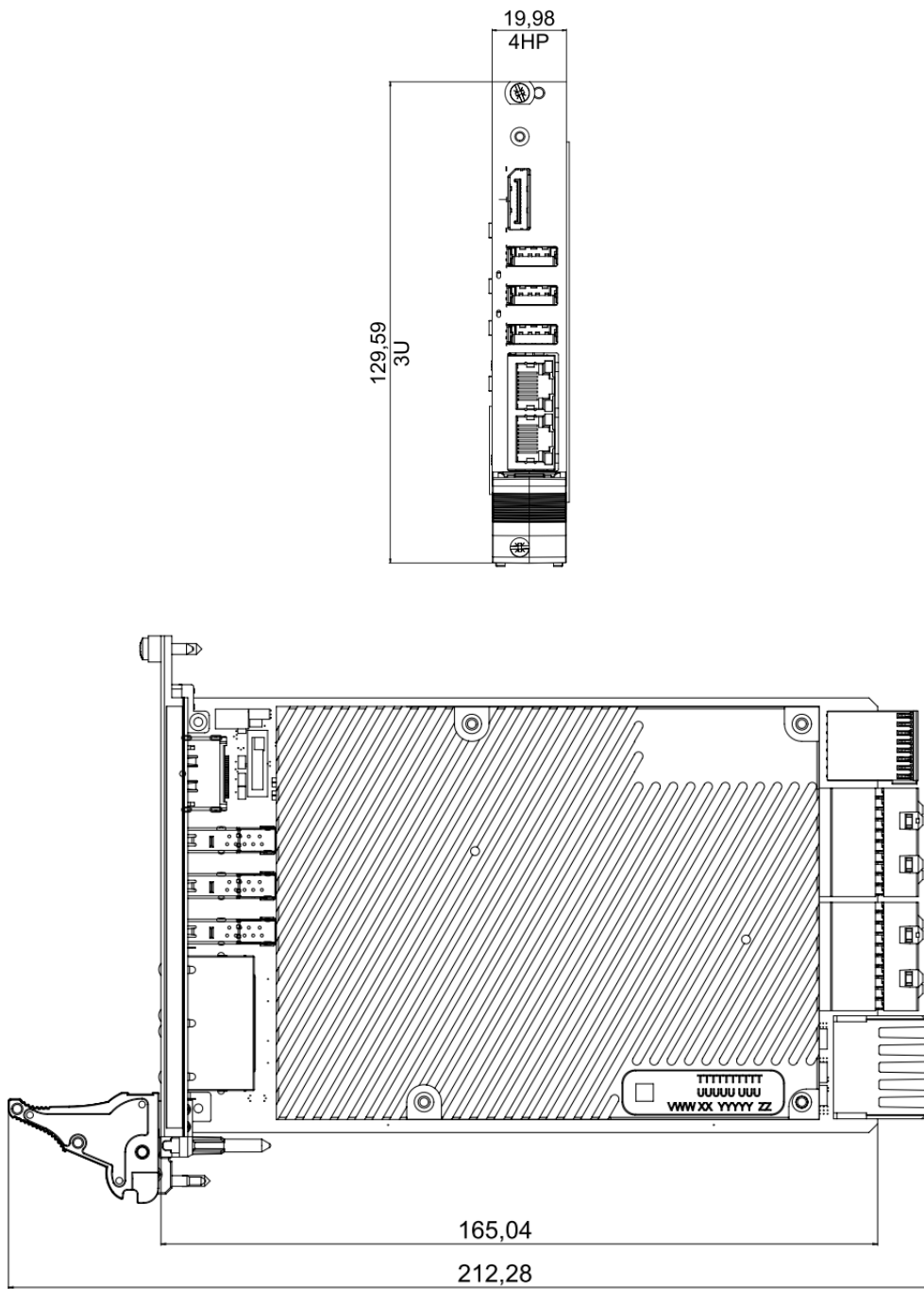

Figure 2: Front and Top View

### 3 General Installation

#### 3.1 Unpacking

#### ATTENTION

When opening the parcel and ESD bag, use caution to avoid damaging the controller.

Consider the following when unpacking and storing the system controller:

- Leave the system controller packed until it is needed for immediate installation.
- After unpacking the system controller, store the packaging material in case the system controller must be returned.

If the packaging is damaged and the system controller shows possible damages, please report it to the shipper and analyze the damage.

#### 3.2 Getting Started / Initial Operation

#### ⚠ WARNING



#### **Risk of injury and accidents due to insufficiently qualified personnel!**

The installation may only be carried out by qualified personnel who are authorized to do so according to the valid safety regulations, e.g. by authorized specialized companies or authorized departments of the company.

1. Plug in the chassis AC cord to have PE grounding potential when inserting controller.
2. Ensure your PXI Express chassis is set to "DEF" and main switch is set to "O" (Off)
3. Gently insert the controller into Slot 1 guiding rails. Ensure the connector zones align properly before inserting till the end.
4. Pull up the front handle slightly until front panel seals with front. Tighten the 4 screws.
5. Press the Push-Button to initiate the power up/booting sequence.
6. During bootup, press ESC to access BIOS settings or F11 for boot options.
7. Use the BIOS menu to set the correct boot priority based on your chosen boot medium (e.g., USB drive, CD-ROM).
8. Select correct Boot Priority in accordance with your selected boot mediums.
9. Install a supported operating system following the manufacturer's instructions.
10. Download and install the necessary drivers from the provided link for full functionality.



**Embedded Controllers or PXI Express External Adapter Cards can only be installed in System Controller Slot (Slot 1). Please use Air Baffles on idle left sided System Controller Slots.**

### 3.3 Safe Shutdown Sequence

Your PXI Express chassis and controller has to be seen like an regular Windows-based PC and should not be shut down by direct unplugging the power cord, switching off the main switch or deasserting the system controller during runtime.

To avoid damaging your system controller, peripheral cards and its data, follow these secure shutdown methods:

1. **Shutdown Process:** Use the familiar shutdown procedure of your OS. This gracefully closes programs and saves data before powering down both the controller and the PXIe chassis.
2. **Push Button Sequence:** If your chassis INHIBIT switch is set to DEF, a quick press of the front panel button will initiate a safe shutdown or sleep mode transition for the controller, depending what is chosen in operating system or BIOS.
3. **Inhibit “MAN” shutdown:** If your chassis INHIBIT switch is set to MAN you can shutdown controller as described in 1. or 2, but main power levels will stay active. For a complete power down please wait until display turns inactive and also set AC main switch to Off (O) or unplug the power cord.

### 3.4 Power Loss Behaviour

For an unexpected case of AC or DC power loss of your chassis you can configure Power Loss Behaviour of your embedded controller. Enter BIOS menu upon bootup (F2) and switch to chapter “Boot”. On parameter “Power Loss Control” you can choose between 3 options:

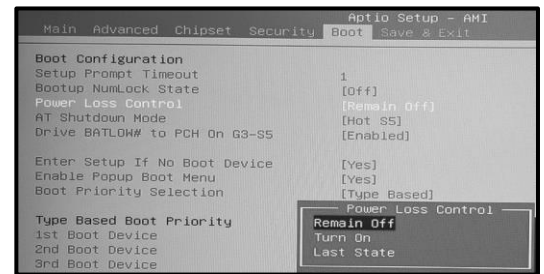

- **Remain Off (default value)**  
After Power Loss event the controller will stay off and not bootup again.
- **Turn On**  
After Power Loss event the controller will start boot sequence into OS
- **Last State**  
After Power Loss event it will either turn on / stay off, dependent on its last state

### 3.5 Cooling recommendations for higher CPU load applications

- **Plenty of Airflow:** Ensure unobstructed airflow to your controller for normal operation. Blocked or enviromental hot air can cause overheating events.
- **Prevent Air shortages:** Use optional air baffles to block unused slots and prevent air "shortcuts" for optimizing cooling.
- **Sealed front :** Ensure all slots and the front panel are sealed with fitting blind front panels or peripheral cards to minimize air leakage and maximize cooling efficiency.
- **Controller Spare Slots:** In chassis with idle left-sided controller slots, use additional baffles to focus airflow directly onto the one slot-sized controller.
- **Monitor Mixed Cards:** When using cards with varying air impedances, monitor cooling performance under specific loads and adjust if necessary.

### 3.6 Supported Operating Systems

The nVent SCHROFF controller 21265-124 offers flexibility when it comes to operating systems, but it's essential to choose one that has the necessary drivers for optimal performance. While it arrives without a pre-installed OS, you have the freedom to select the system that best suits your needs. It's crucial to ensure the chosen operating system has compatible drivers available. While nVent SCHROFF has tested and confirmed compatibility with the listed options, using unsupported operating systems or drivers can lead to performance issues or malfunctions.

#### Evaluated Operating Systems

- Windows: Windows 11 Pro 64-bit 23H2 Built 22631.3155 (widely supported)  
**Windows 10 Pro 64-bit 22H2 Built 19045.3448 (recommended)**
- Linux: Ubuntu 22.04 LTS (widely supported)

### 3.7 Software and Driver Installation

For Windows 10 users, download and install the necessary driver package from this link:

<https://schroff.nvent.com/products/enc21265-124>

If you're using other Windows versions, Linux, NI Realtime or else, please contact your local sales representative for specific driver package, instructions and optional technical support.

Once you've installed your chosen OS, complete the setup by installing the SCHROFF PXIe Initial Setup software package. This package includes essential drivers, a system manager tool, pre-configured INI files, and registry settings for optimal PXI system operation. Download the latest version of nVent SCHROFF PXIe Initial Setup from link above.

	<p>Before installing the SCHROFF Initial Setup it is mandatory to install a PXI Resource Manager Software Environment, e.g. NI™ Max or Keysight™ Connection Expert.</p>
---	---

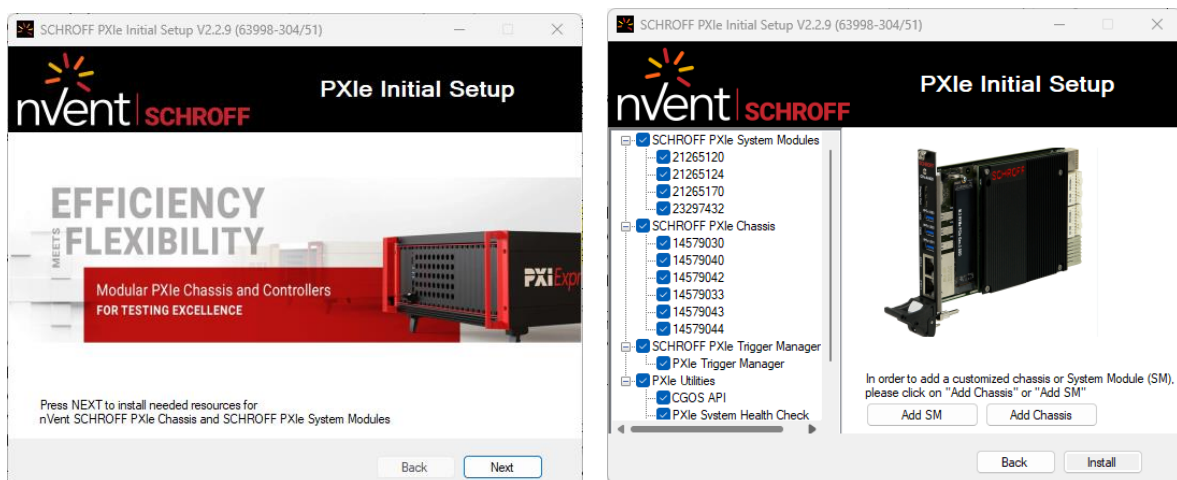
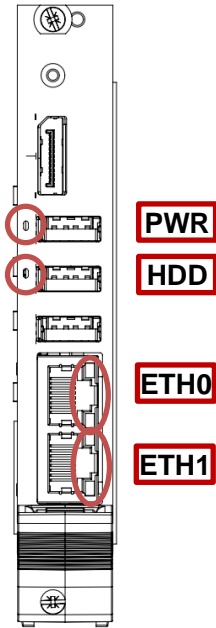

Figure 3: Screenshot of nVent SCHROFF PXIe Initial Setup

## 4 Interface description

### 4.1 Front Panel LED Indicators



On the front panel of the embedded controller there are two status control LEDs and two indicator LEDs per Ethernet port. At the following table the functions and a short description of their indicated behavior are listed.

Function	Color	LED status	Behavior
PWR	Green	Off On (solid)	System power off or idle PWR_OK asserted / bootable
HDD	Green	Off On (blinks)	Internal NVMe drive is inactive Data transfer on int. NVMe drive
ETH0 or ETH1	Green Dual	On (blinks) Off Green (solid) Amber (solid)	Network link established / active Link Speed is 10 or 100 Mbps Link Speed is 1 Gbps Link Speed is 2.5 Gbps

Table 3: Front Panel LED Indicators

### 4.2 DisplayPort

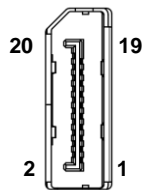

The front Display Port is capable of Dual-Mode (DP++) and offers additional flexibility. It converts HDMI and DVI signals when attached with a non-active cable type and supports the following interfaces:

- VESA DisplayPort Standard 1.2
- data rate of up to 5.4 GT/s on 4 data lanes
- up to 4096x2304 resolutions at 60 Hz
- Audio formats: AC-3 Dolby Digital, Dolby Digital Plus, DTS-HD, LPCM, 192 KHz/24 bit, Dolby TrueHD, DTS-HD Master Audio

### 4.3 USB

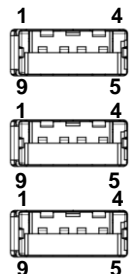

There are three USB 3.2 Type A connectors located on the front panel. The xHCI host controller supports USB 3.2 specification with all signaling speeds (SuperSpeedPlus down to Low-Speed). A data transfers rate of up to 10 Gbps for USB 3.2 Gen 2x1 compatible decices and the USB debug feature. Each port can support up to 1500 mA load on 5.0V level.

More powerful devices may be under supported due to current limitation.



**When using USB 2.0 or USB 3.0 unshielded cables,** it is recommended using a ferrite within a cable loop at 5-8cm far from the endpoint to reduce EMI effects. Please ensure your device meets local EMC standards.

#### 4.4 Ethernet

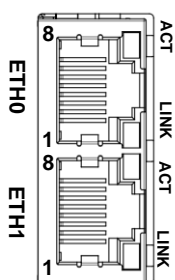

The embedded controller offers two 2.5 Gigabit Ethernet interfaces via an onboard Intel® i225 or i226LM/V/IT Phy. The interface supports:

- Full-duplex operation at 10/100/1000/2500 Mbps
- Half-duplex operation at 10/100 Mbps
- Can act as EtherCAT master (3<sup>rd</sup> party driver required)

Wake On Lan Feature is supported and has to be configured within the device driver or in the BIOS settings to be active.

#### 4.5 I<sup>2</sup>C / SMBUS Interface

The controller supports I<sup>2</sup>C (fast mode, multi-master) on hardware level and in addition the SMBus protocol. The SMBus interface acts as your gateway to the inner of your PXI Express system. It allows you to access and control various PXI Express SMBUS devices throughout the chassis, unlocking their functionalities. Additionally, you can retrieve essential information like chassis and controller EEPROM data.

Within a nVent SCHROFF chassis, you can monitor real-time temperature, fan speeds, and voltage levels, gaining valuable insights into system health. Moreover, you can directly apply desired configurations, adjusting fan speeds, setting trigger segments and maintaining specific firmware parts for optimal operation.

To have access to SMBus please install the latest version of nVent PXI Express Initial setup for driver support. Also an general API based on the SMBUS register mapping is available and let you easy design-in into your application. For further information please get in contact to your sales partner.

## 5 Safety

### 5.1 Safety Instructions - Disclaimer

nVent SCHROFF accepts no liability for any errors in this documentation. To the maximum extent permissible by law, any liability for damage, direct or indirect, arising from the supply or use of this documentation is excluded.

nVent SCHROFF retains the right to modify this document, including the liability disclaimer, at any time without notice and accepts no liability for any consequences of such alterations.

### 5.2 Safety Symbols

In these original operating instructions, warning notices point out residual risks that cannot be avoided by constructive means when installing or operating the PXI Express System Controller. The warning notices are classified according to severity of the damage occurring and its statistic occurrence.

 <b>DANGER</b>	
Symbol	<b>Short description of the danger</b> The signal word DANGER indicates an immediate danger. Non-observance will result in severe injuries or death.

 <b>WARNING</b>	
Symbol	<b>Short description of the danger</b> The signal word WARNING indicates a possible danger. Non-observance can lead to serious injury or death.

 <b>CAUTION</b>	
Symbol	<b>Short description of the danger</b> The signal word CAUTION indicates a possible danger. Non-observance can lead to injuries.

<b>ATTENTION</b>	
<b>Short description</b> The signal word ATTENTION indicates possible damages to equipment. Non-observance can lead to damage to the device.	

	<b>Important information</b>
---	------------------------------



## 6 Service

### 6.1 Technical support and Return for Service Assistance

nVent SCHROFF actively informs their customer about EOL, service expirations and software updates by customer information letters.

We generally recommend to return the complete system controller. For all product returns and support issues, please contact your local nVent SCHROFF sales representative to connect you to our technical support team. We recommend that you save the packing material. Shipping without the original packing material will void the warranty.

### 6.2 Warranty

All nVent SCHROFF hardware features a two-year standard warranty that is extendable upon request. nVent SCHROFF offers repair services performed in a timely manner by highly trained factory technicians.

Declaration of Conformity (DoC)—A DoC is our claim of compliance with the Council of the European Communities using the manufacturer's declaration of conformity. This system affords the user protection for electromagnetic compatibility (EMC) and product safety. You can obtain the DoC for your product on the corresponding product page on our website <https://SCHROFF.nvent.com/>

### 6.3 Disposal

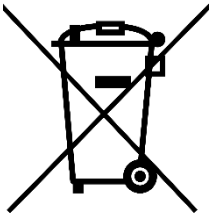

The devices described in this manual must be recycled. In accordance with the Directive 2012/19/EC on waste electronic and electrical equipment (WEEE), they may not be disposed of in the municipal waste disposal services. To ensure environmentally friendly recycling the devices can be returned to a locally approved disposal center. Make sure that you observe the regulations applicable in your country.

## 7 Figures

Figure 1: Isometric Front View .....	8
Figure 2: Front and Top View .....	10
<b>Figure 3: Screenshot of nVent SCHROFF PXle Initial Setup .....</b>	<b>13</b>

## 8 Tables

Table 1: Revision History.....	2
Table 2: Technical Data.....	7
Table 3: Front Panel LED Indicators.....	14