

1 (6x)



2 (6x)



3 (6x)

Toleranz von $\pm 15\%$ auf alle Anziehdrehmomente, sofern nicht anders angegeben.

Tightening torques are given with a tolerance of $\pm 15\%$ unless otherwise stated.

Les couples de serrages sont donnés avec une tolérance de $\pm 15\%$ sauf autre indication.

A

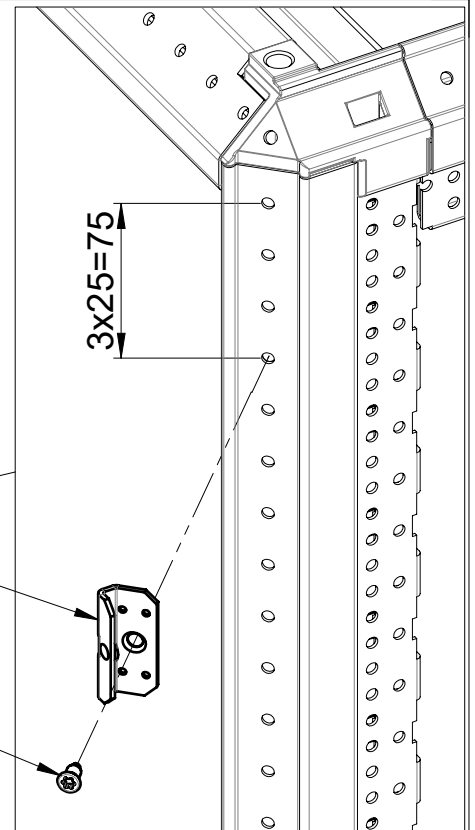
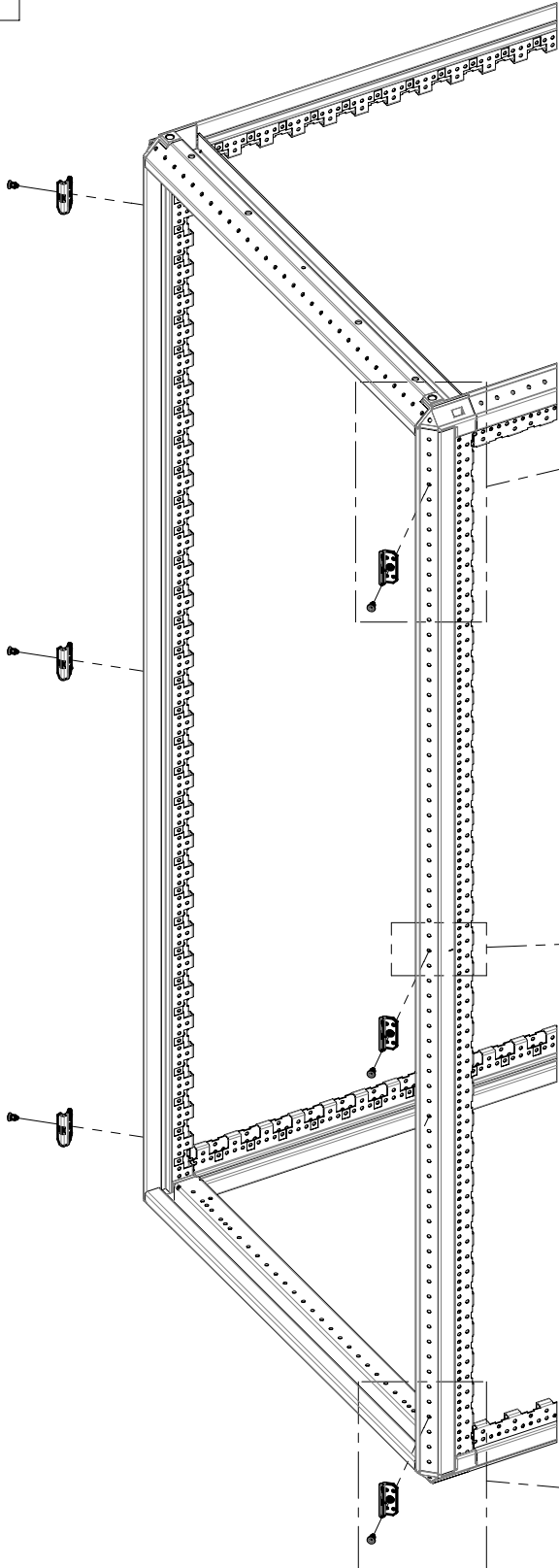

1 (6x)

2 (6x)
(3.5 Nm)

3x25=75

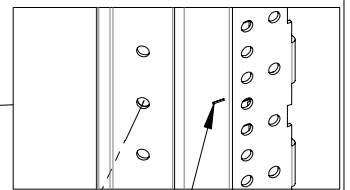

Markierung
Marking
Marquage

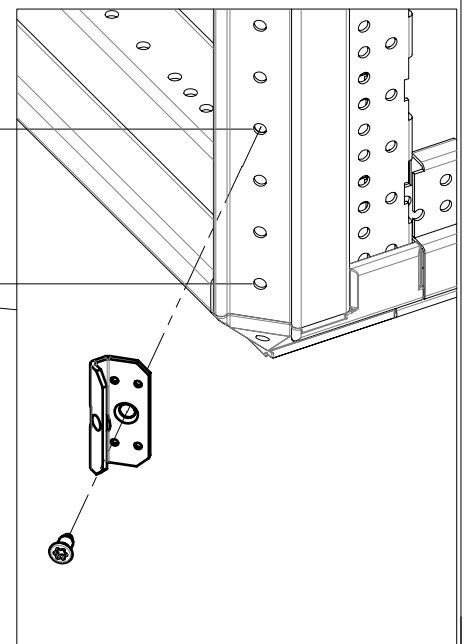

3x25=75

B

2

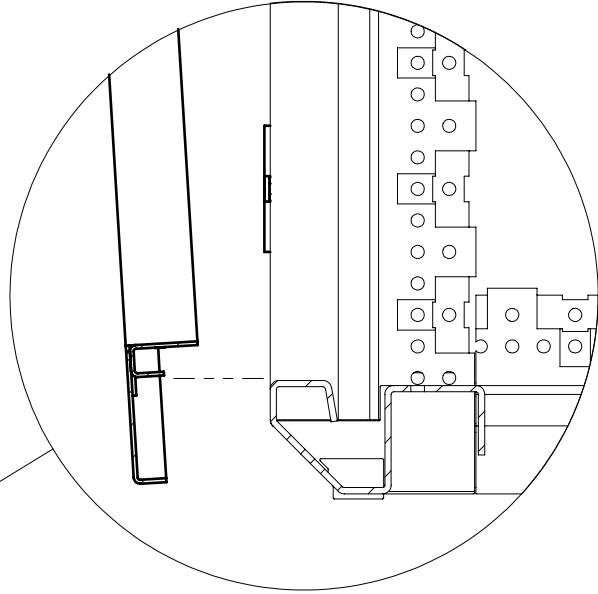
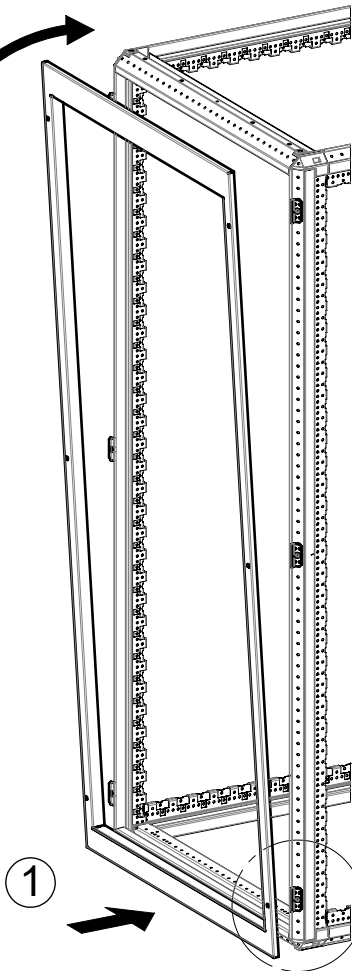

C

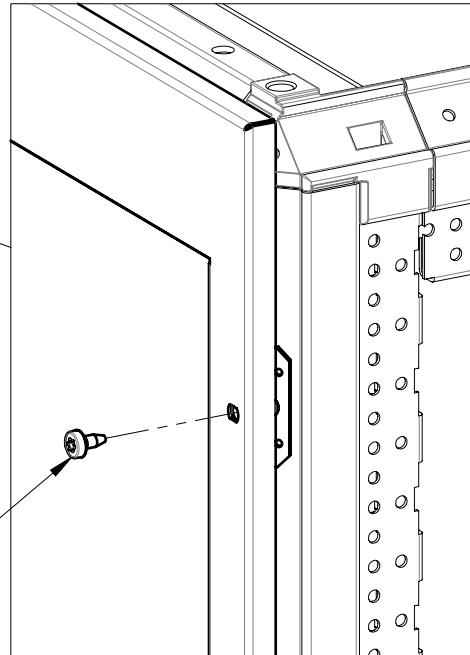
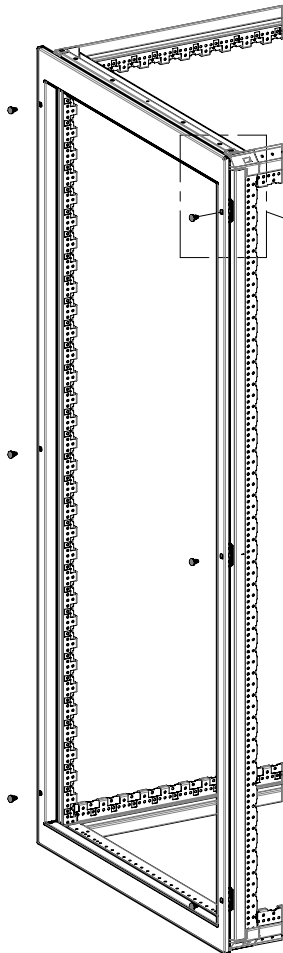

3 (6x)
(3.5 Nm)