



**SCHROFF**

# 3 U MTCA Shelf

## User's Manual



**Product Number:**

**11890-164**

R1.0	November 2020	Initial release

Impressum:

Schroff GmbH

Langenalber Str. 96 - 100  
75334 Straubenhardt, Germany

The details in this manual have been carefully compiled and checked - supported by certified Quality Management System to EN ISO 9001/2000

The company cannot accept any liability for errors or misprints. The company reserves the right to amendments of technical specifications due to further development and improvement of products.

Copyright © 2020

All rights and technical modifications reserved.



<b>1</b>	<b>Safety .....</b>	<b>1</b>
1.1	Safety Symbols used in this document.....	1
1.2	General Safety Precautions.....	1
1.3	References and Architecture Specifications.....	1
<b>2</b>	<b>Hardware Platform .....</b>	<b>2</b>
2.1	Introduction .....	2
2.2	Front and Rear View.....	2
<b>3</b>	<b>Backplane .....</b>	<b>3</b>
3.1	Backplane Topology .....	3
3.2	Intelligent Platform Management Bus (IPMB) .....	4
3.2.1	IPMB-L.....	4
3.2.2	IPMB-0 .....	4
3.3	Carrier FRU SEEPROM .....	4
3.4	Carrier Number .....	4
3.4.1	Mechanical DIP Switch.....	5
3.4.2	Electronic DIP Switch (factory default) .....	5
3.5	JTAG.....	6
<b>4</b>	<b>Air Filter.....</b>	<b>8</b>
<b>5</b>	<b>Cooling Unit.....</b>	<b>9</b>
5.1	Power .....	10
<b>6</b>	<b>Technical Data .....</b>	<b>11</b>
6.1	Dimensions.....	12



# 1 Safety

The intended audience of this User's Manual is system integrators and hardware/software engineers.

## 1.1 Safety Symbols used in this document

	<p><b>Hazardous voltage!</b></p> <p><i>This is the electrical hazard symbol. It indicates that there are dangerous voltages inside the Shelf.</i></p>
	<p><b>Caution!</b></p> <p><i>This is the user caution symbol. It indicates a condition where damage of the equipment or injury of the service personnel could occur. To reduce the risk of damage or injury, follow all steps or procedures as instructed.</i></p>
	<p><b>Danger of electrostatic discharge!</b></p> <p><i>The Shelf contains static sensitive devices. To prevent static damage you must wear an ESD wrist strap.</i></p>

## 1.2 General Safety Precautions

	<p><b>Warning!</b></p> <p><i>Voltages over 60 VDC can be present in this equipment. As defined in the PICMG 3.0 Specification, this equipment is intended to be accessed, to be installed and maintained by qualified and trained service personnel only.</i></p>
---	---

- Use of this product in a manner not specified by the manufacturer may impair the safety protection of this equipment.
- Service personnel must know the necessary electrical safety, wiring and connection practices for installing this equipment.
- Install this equipment only in compliance with local and national electrical codes.
- For additional information about this equipment, see the PICMG MicroTCA Specification ([www.picmg.com](http://www.picmg.com)).

## 1.3 References and Architecture Specifications

- PICMG<sup>®</sup> MTCA.0 Specification
- PICMG<sup>®</sup> MTCA.4 Specification
- PICMG<sup>®</sup> AMC<sup>®</sup> Base Specification ([www.picmg.com](http://www.picmg.com))

## 2 Hardware Platform

### 2.1 Introduction

The Schroff 11890-164 is a 3 U MicroTCA.4 Shelf with rear  $\mu$ RTM area for AMC modules and RTMs, front to rear airflow and MTCA.4 backplane topology.

#### Features:

- Shielded galvanisized steel subrack with 19" rack mounting brackets
- MicroTCA Backplane with radial IPMI-L from the MCH slot to all AMC slots and bused IPMB-0 among MCH, PMs and CU.
- The system provides:
  - 4 AMC double Mid-size slots with RTM
  - 1 AMC double Mid-size slot
  - 1 AMC Double Full-size slot
  - 1 MicroTCA Carrier Hub (MCH) double Full-size slot
  - 2 Power Module (PM) double full-size slots
  - 1 JSM slot
- Hot swappable fan tray with MTCA Cooling Unit Management
- Front to rear cooling with front accessible air filter

### 2.2 Front and Rear View

Figure 1: Front and RearView



1 Air inlet  
2 Air filter

3 Cooling Unit  
4 Slot for optional JSM JTAG Module

### 3 Backplane

#### 3.1 Backplane Topology

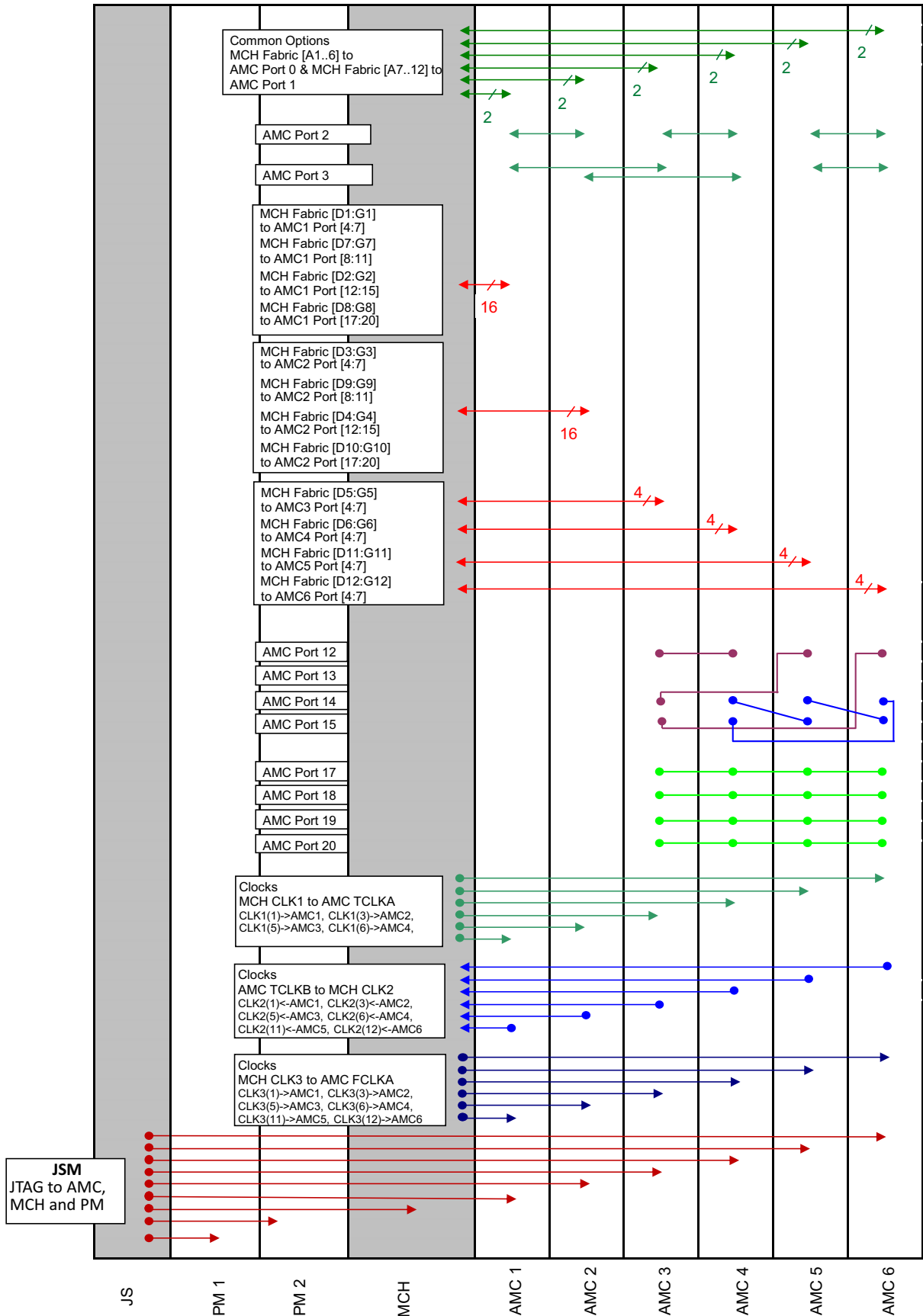

## 3.2 Intelligent Platform Management Bus (IPMB)

MicroTCA uses an Intelligent Platform Management Bus (IPMB) for management communications.

### 3.2.1 IPMB-L

The IPMB among AdvancedMCs and the MCHs is non-redundant and implemented in a radial topology. This IPMB called Local IPMB (IPMP-L)

### 3.2.2 IPMB-0

The IPMB among the MCH, the PM and the CU is called IPMB-0. The reliability of the IPMB-0 is improved by the addition of a second IPMB, with the two IPMBs referenced as IPMB-A and IPMB-B.

The IPMB-A and IPMB-B are routed in a bused configuration.

## 3.3 Carrier FRU SEEPROM

The Carrier FRU SEEPROM is located at the backside of the Backplane. The SEEPROM is connected to both MCHs through I<sup>2</sup>C-busses.

The I<sup>2</sup>C-addresses of the SEEPROM is 0xa4.

## 3.4 Carrier Number

Each MicroTCA Carrier shall have a unique Carrier Number, ranging from 1 to 16 in its MicroTCA Shelf. To provide the Carrier Number, a mechanical and electronic (PCA9558) DIP switch and a PCF8574A I<sup>2</sup>C I/O expander is located on the Backplane behind the Power Module (PM).

Figure 2: Carrier Number DIP Switch

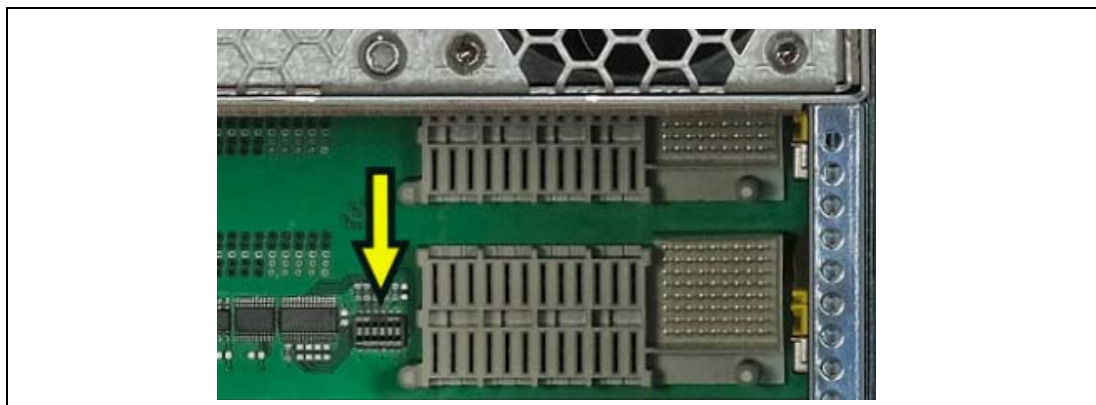
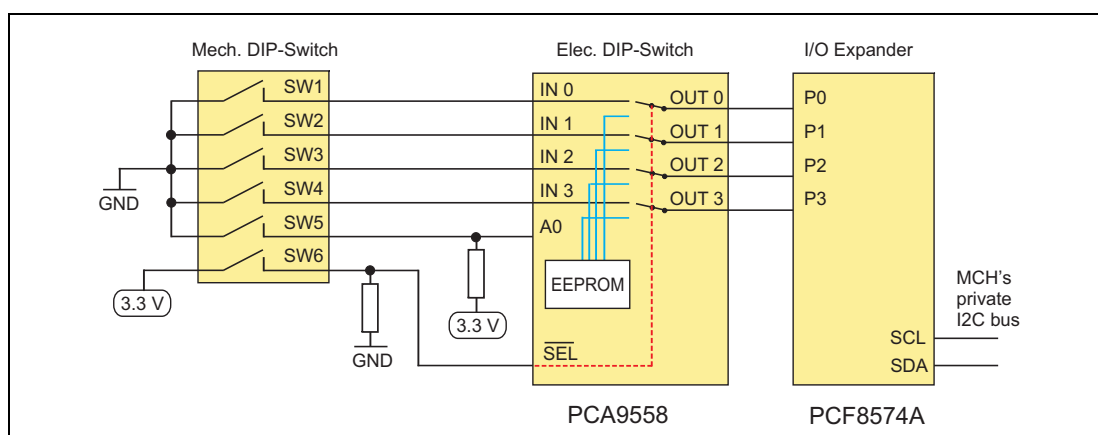

Figure 3: Carrier Number setting block diagram





### 3.4.1 Mechanical DIP Switch

The mechanical DIP switch is a 6-position switch.

- Switch 1 to 4 are used to set the carrier number (Switch 1 = Bit 0).
- Switch 5 is used to change the I2C-address of the electronic DIP switch.
  - Switch 5 ON: address = 9C
  - Switch 5 OFF: address = 9E
- With switch 6 you can select between mechanical or electronic DIP switch to set the carrier number.
  - Switch 6 ON: Mechanical DIP switch active
  - Switch 6 OFF: Electronic DIP switch active



The DIP Switch is located on the Backplane. It is user-accessible after removing the PM.

When setting the carrier number with the mechanical DIP switch please note:

Switch ON = logic 0

Switch OFF = logic 1

The mechanical DIP switch is connected to the input of the electronic DIP switch. When the SEL signal is a logic 0, the electronic DIP switch will select the data from the internal EEPROM to drive the output pins, when the SEL signal is a logic 1, the electronic DIP switch will select the signal from the mechanical DIP switch to drive on the output pins.

### 3.4.2 Electronic DIP Switch (factory default)

The electronic DIP switch is connected to the lower four bits of the I/O lines of the PCF8574A I<sup>2</sup>C I/O expander. The I/O expander connects to the MCH’s private I<sup>2</sup>C bus. The MCH reads the DIP switch setting from the I/O expander, adds one, and uses the result as its Carrier Number.



In the default factory setting the electronic DIP switch is active at the address 0x9E (SW5 and SW6 at the mechanical DIP switch = OFF)

Default carrier address = 1 (Data content EEPROM = 0000)

I<sup>2</sup>C Addresses

PCA 9558 DIP switch	0x9e or 0x9c	0x9e or 0x9c = 8 bit address write (bit 0 = 0)
PCF8574A I/O expander	0x7c	0x3e = 7 bit address (8 bit address read = 0x7d)

To change the carrier number with the electronic DIP switch you have to send the following I2C command to the electronic DIP switch’s EEPROM:

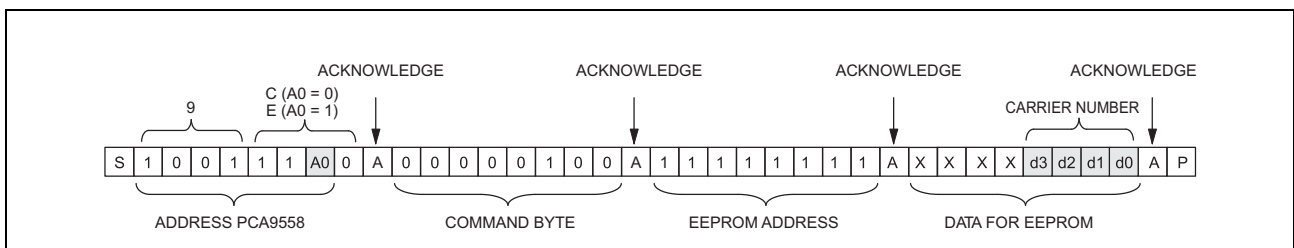

### 3.5 JTAG

The system provides a single full size slot for a custom specific JTAG Switch Module (JSM) at the rear side.

Figure 4: JSM slot

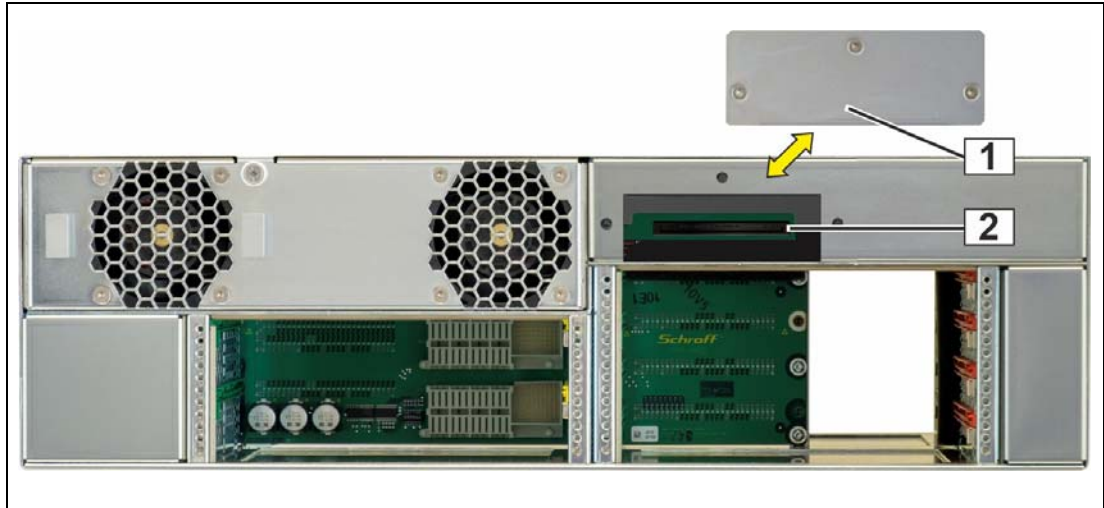

1 Cover

2 JSM slot

JSM slot pinout

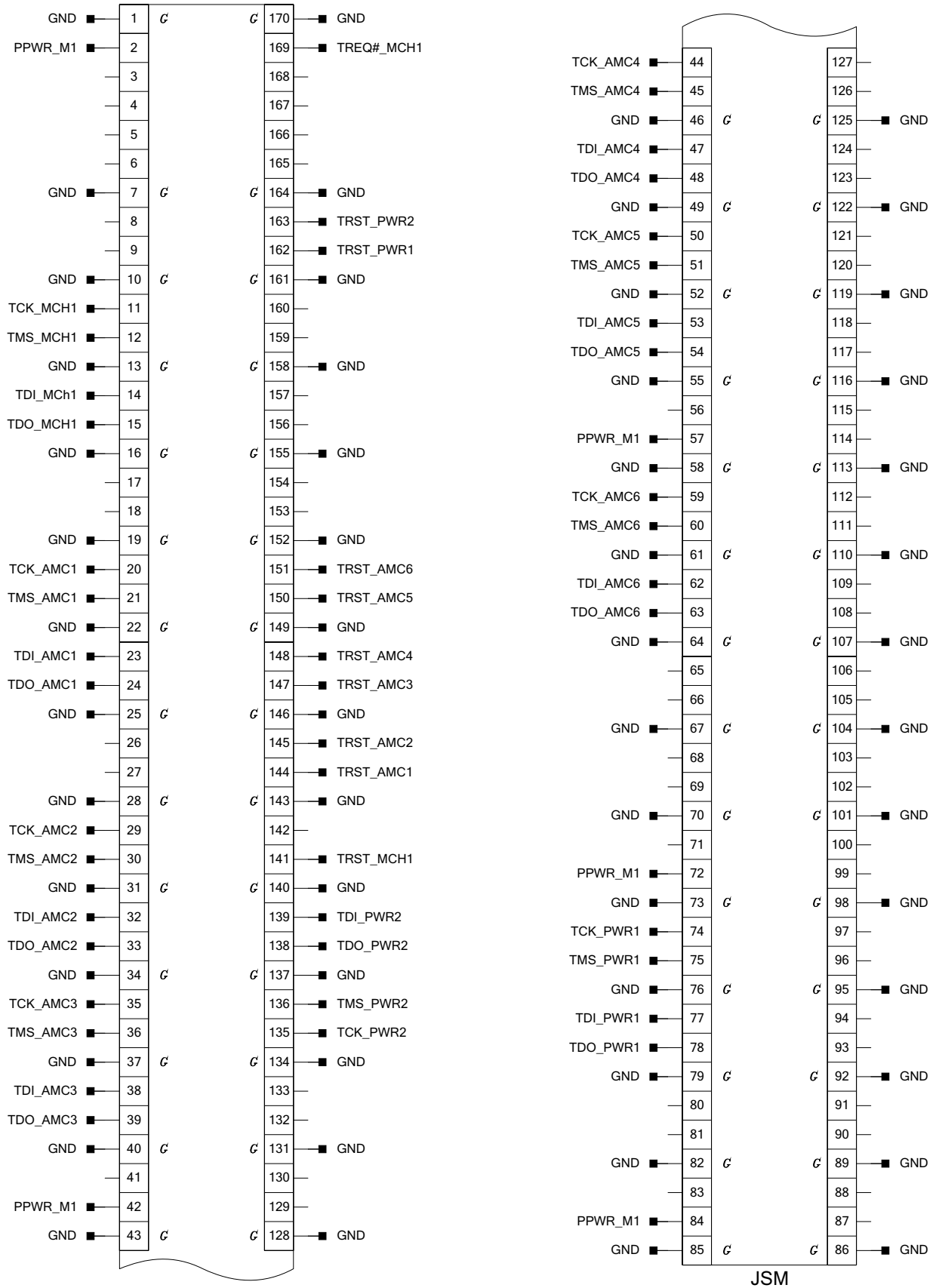

## 4 Air Filter

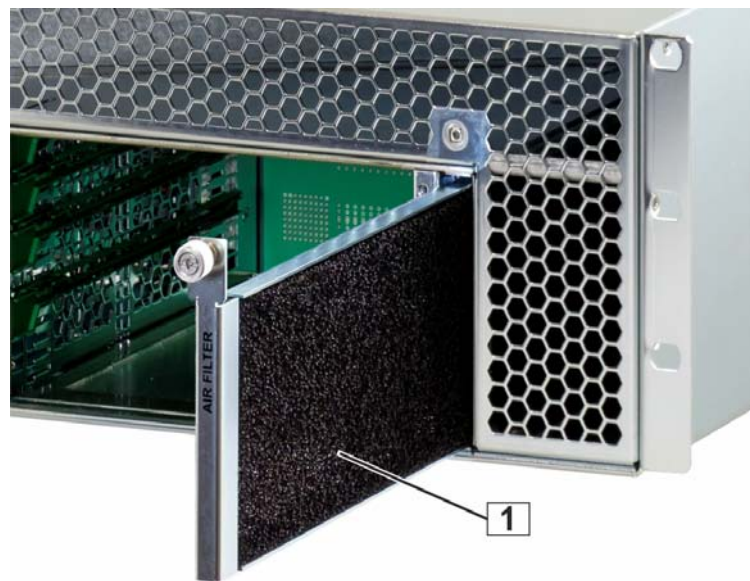

The MicroTCA Shelf provides a front replaceable air filter (1).

The filter meets the following standards and classifications:

- UL 900 Class 2, UL94 HF-1
- Telcordia NEBS GR-78-CORE
- Telcordia NEBS GR-63-CORE

## 5 Cooling Unit

The MicroTCA Shelf provides a rear-pluggable Cooling Unit.

The Cooling Unit contains four high air flow fans in a twin configuration and a Schroff Cooling Unit Enhanced Module Management Controller (CU EMMC). The CU EMMC has an Enhanced Module Management Controller (EMMC) onboard that communicate with the Carrier Manager over IPMB-0. The CU EMMC controls the fan speed and provides hot-swap functionality.



*During operation of the chassis, the fans are controlled by the MCH.*

*For further informations about the cooling strategy and behaviour contact the MCH manufacturer.*

The bulk airflow, measured with flow impedance boards is:

- Fan level 1: 63 m<sup>3</sup>/h (37 CFM)
- Fan level 15: 170 m<sup>3</sup>/h (100 CFM)

**Figure 5: Cooling Unit**



1 Cooling Unit

For more demanding cooling requirements, a fan tray with 6 fans and 2 EMMC is available on request.

**Figure 6: Cooling Unit 6 fan**



## 5.1 Power

The MTCA.4 system provides 2 Power Module (PM) slots for Double Full-size Power Modules at the rear side.

Figure 7: Power Module slots

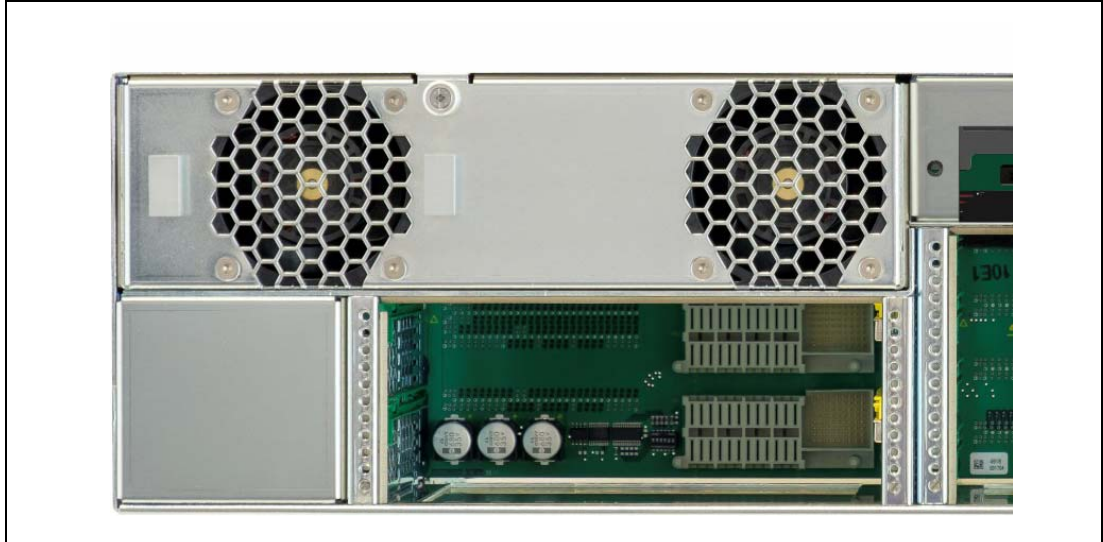

## 6 Technical Data

Table 1: Technical Data

<b>Physical Dimensions</b>	
Height	131.55 mm (3 U)
Width (with mounting brackets)	482.60 mm (19")
Width (w.o. mounting brackets)	448,00 mm
Depth	approx. 379 mm
<b>Weight</b>	
Weight completely assembled	approx. 8 kg
<b>Environmental</b>	
Ambient temperature	+5°C...+40°C (long term)
Ambient temperature	-5°C...+50°C (short term)
Humidity	+5%...+85%, non-condensing

## 6.1 Dimensions

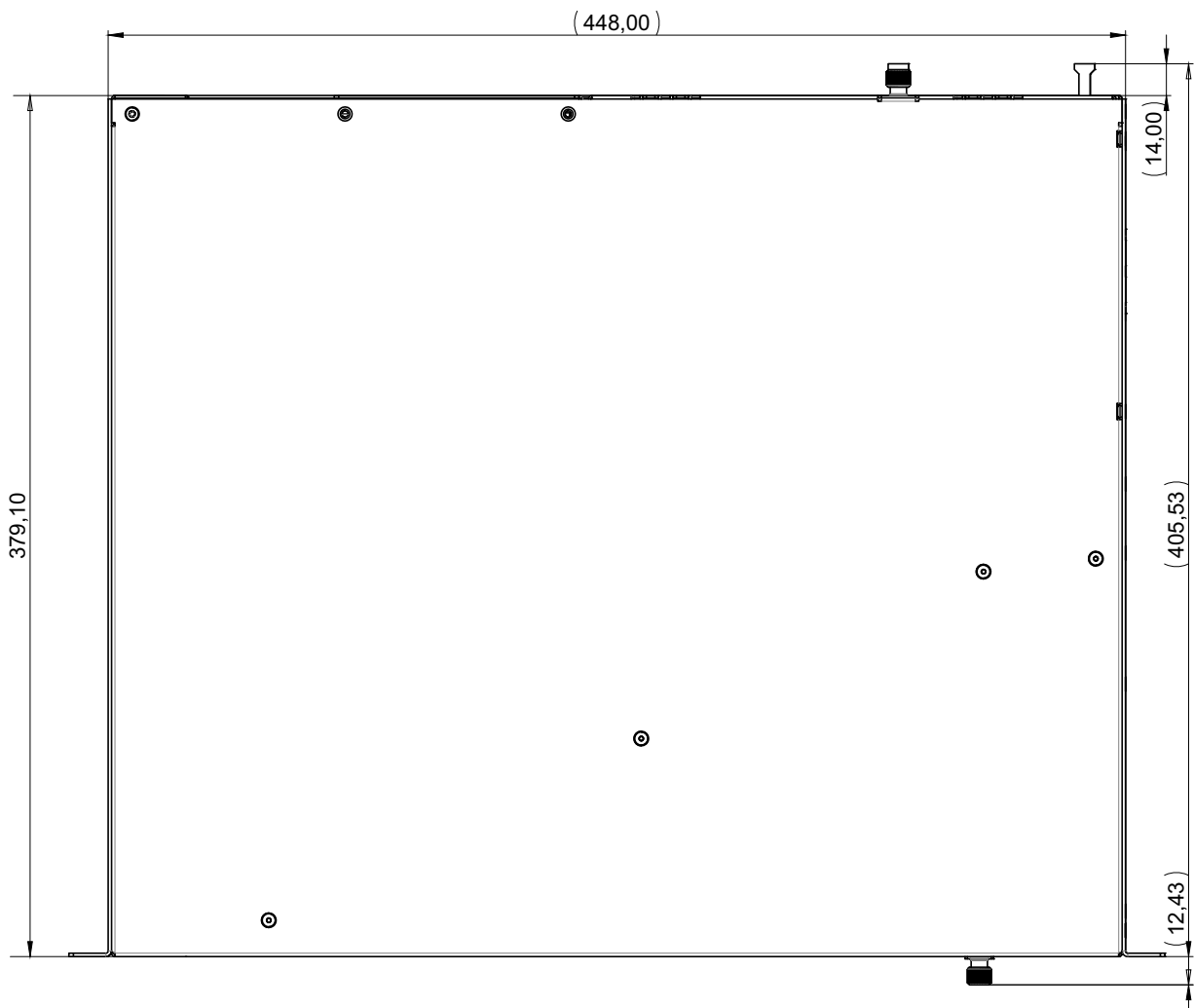
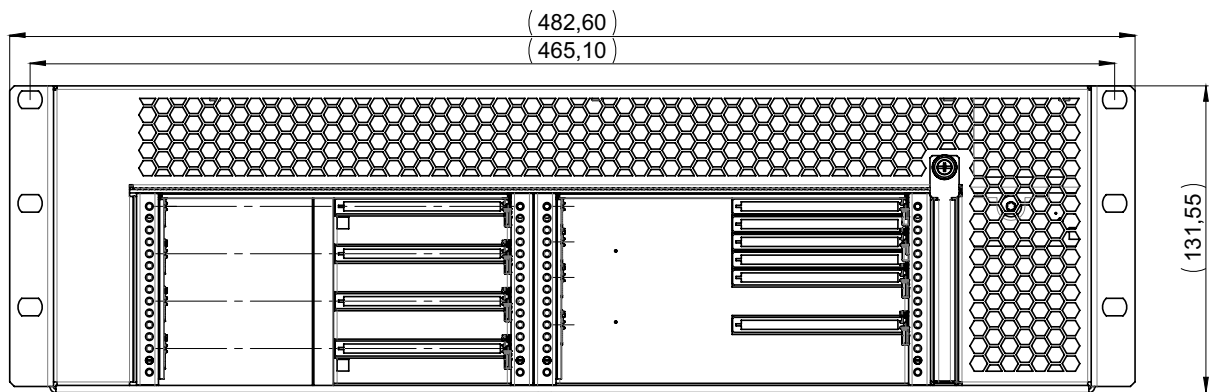





**Schroff GmbH**

Langenalber Str. 96 - 100  
75334 Straubenhardt, Germany  
Tel +49.7082.794.0  
Fax +49.7082.794.200