

10713-140 1 U AIR DEFLECTOR FOR 19" FAN TRAY, 3 FANS, FRONT PERFORATED, 193 MM, RAL 7035

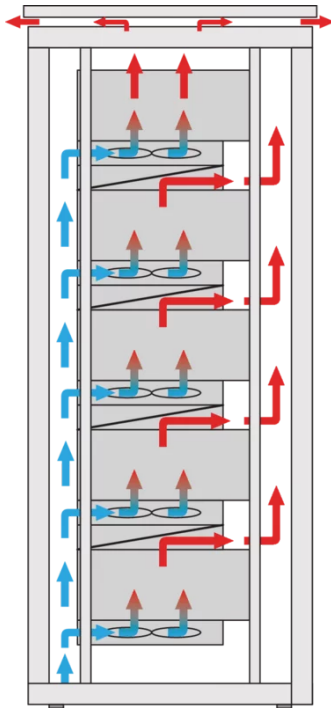
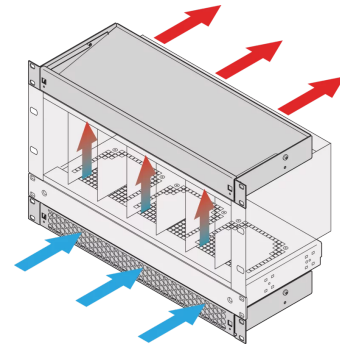

**KEY FEATURES**

Assembly options: – One fan tray: cool air is drawn in from the front and guided upwards – Two fan trays: cool air is drawn in from the front, directed upwards and guided to the rear (see application diagram)

Optimised cooling together with 19" fan trays

Vertical buildup of heat is avoided via improved airflow

Optional filter mat, simple to swap during operation

## PRODUCT ATTRIBUTES

---

Product Type: Air Guide

Product Family: Novastar; Varistar

Works With: 19" Fan Trays

## ADDITIONAL PRODUCT DETAILS

---

Air deflector with 1 U height to guide the air from front to top or from bottom to rear.

## CERTIFICATIONS

---



### North America

All locations

+1.763.422.2661

Chat with us:

[schroff.nvent.com](https://schroff.nvent.com)

### Europe

Straubenhardt, Germany

+49.7082.794.0

Betschdorf, France

+33.3.88.90.64.90

Warsaw, Poland

+48.22.209.98.35

Assago, Italy

+39.02.932.7141

Chat with us:

[schroff.nvent.com](https://schroff.nvent.com)

### Asia

Shanghai, China

+86.21.2412.6943

Qingdao, China

+86.532.8771.6101

Singapore

+65.6768.5800

Shin-Yokohama, Japan

+81.45.476.0271

Chat with us:

[schroff.nvent.com](https://schroff.nvent.com)

### Middle East & India

Dubai, United Arab Emirates

+971.4.378.1700

Bangalore, India

+91.80.6715.2001

Istanbul, Turkey

+90.216.250.7374

Chat with us:

[schroff.nvent.com](https://schroff.nvent.com)



Our powerful portfolio of brands:  
**nVent.com CADDY ERICO HOFFMAN RAYCHEM SCHROFF TRACER**

© 2024 nVent. All nVent marks and logos are owned or licensed by nVent Services GmbH or its affiliates. All other trademarks are the property of their respective owners.

nVent reserves the right to change specifications without notice.