

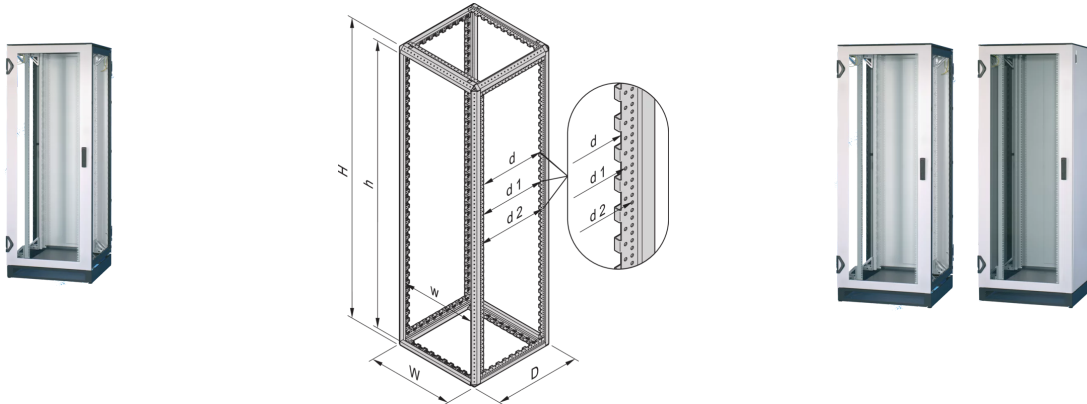

SCHROFF

10130-091 VARISTAR NET PLUS CABINET, RAL 7035, SIDE-BY-SIDE, 42 U, 2000H, 600W, 800D



KEY FEATURES

Available as side by side or standalone rack

Cabling cabinet with two 19"planes and base/plinth

Type of protection IP 20

PRODUCT ATTRIBUTES

Product Type: Rack

Product Family: Varistar

Frame Material: Steel

Cladding Material: Steel

Frame Color: Black Grey

Frame Color Code: RAL 7021

Cladding Color: Light Grey

Cladding Color Code: RAL 7035

Rack Height: 42 U

Height: 2000 mm

Width: 600 mm

Depth: 800 mm

Static Load: 800 kg

ADDITIONAL PRODUCT DETAILS

Basic rack to support cabling and networking equipment. Cooling via convection or top cover fans.

CERTIFICATIONS



North America

All locations
+1.763.422.2661
Chat with us:
schroff.nvent.com

Europe

Straubenhardt, Germany
+49.7082.794.0
Betschdorf, France
+33.3.88.90.64.90
Warsaw, Poland
+48.22.209.98.35
Assago, Italy
+39.02.932.7141
Chat with us:
schroff.nvent.com

Asia

Shanghai, China
+86.21.2412.6943
Qingdao, China
+86.532.8771.6101
Singapore
+65.6768.5800
Shin-Yokohama, Japan
+81.45.476.0271
Chat with us:
schroff.nvent.com

Middle East & India

Dubai, United Arab Emirates
+971.4.378.1700
Bangalore, India
+91.80.6715.2001
Istanbul, Turkey
+90.216.250.7374
Chat with us:
schroff.nvent.com



Our powerful portfolio of brands:
nVent.com **CADDY ERICO HOFFMAN RAYCHEM SCHROFF TRACER**

© 2024 nVent. All nVent marks and logos are owned or licensed by nVent Services GmbH or its affiliates. All other trademarks are the property of their respective owners.

nVent reserves the right to change specifications without notice.