

11249-009 OUTDOOR UNIBODY VENT CABINET WITH SINGLE DOOR, 1100H 20 U, 700W 500D

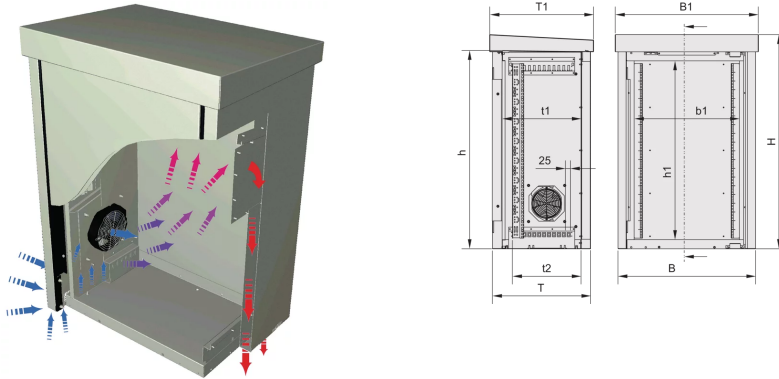

KEY FEATURES

Double-walled, Al

Forced heat dissipation via fan assembled in side panel, max. 35 W/K

IP 55

One-piece inner case with removable outer cladding

PRODUCT ATTRIBUTES

Product Type: Outdoor Cabinet

Product Family: Unibody

Rack Height: 20 U

Height: 1100 mm

Width: 700 mm

Depth: 500 mm

Wall Type: Double Walled

Door Type: Single Door

Access: Front

Cooling: Fan Ventilation

EMC Shielding: No

Complies With: IEC 61969-1; IEC 61969-2; IEC 60917-1; IEC 60917-2; ETS 300119; IEC 60529; DIN EN 50178; VDE 0160

ADDITIONAL PRODUCT DETAILS

Telecom and Railway applications require sophisticated electronics in outdoor setups. nVent SCHROFF Outdoor cabinets shield such electronic components from extreme weather and vandalism, ensuring operational continuity.

Please order wall-mounting assembly kit separately.

Further base/plinth heights on request.

Please order panel/slide mounts separately.

CERTIFICATIONS



North America

All locations
+1.763.422.2661
Chat with us:
schroff.nvent.com

Europe

Straubenhardt, Germany
+49.7082.794.0
Betschdorf, France
+33.3.88.90.64.90
Warsaw, Poland
+48.22.209.98.35
Assago, Italy
+39.02.932.7141
Chat with us:
schroff.nvent.com

Asia

Shanghai, China
+86.21.2412.6943
Qingdao, China
+86.532.8771.6101
Singapore
+65.6768.5800
Shin-Yokohama, Japan
+81.45.476.0271
Chat with us:
schroff.nvent.com

Middle East & India

Dubai, United Arab Emirates
+971.4.378.1700
Bangalore, India
+91.80.6715.2001
Istanbul, Turkey
+90.216.250.7374
Chat with us:
schroff.nvent.com



Our powerful portfolio of brands:
[nVent.com](https://nvent.com) **CADDY ERICO HOFFMAN RAYCHEM SCHROFF TRACER**

© 2024 nVent. All nVent marks and logos are owned or licensed by nVent Services GmbH or its affiliates. All other trademarks are the property of their respective owners.

nVent reserves the right to change specifications without notice.